

**RELIABLE ADAPTABILITY**  
FOR SECURITY SYSTEMS



**SECURE COMMUNICATION**  
**FOR THE WAY YOU WORK.**

# “ Our mission

is to simplify and accelerate technological change in security services by creating equipment that is easy to install and use.

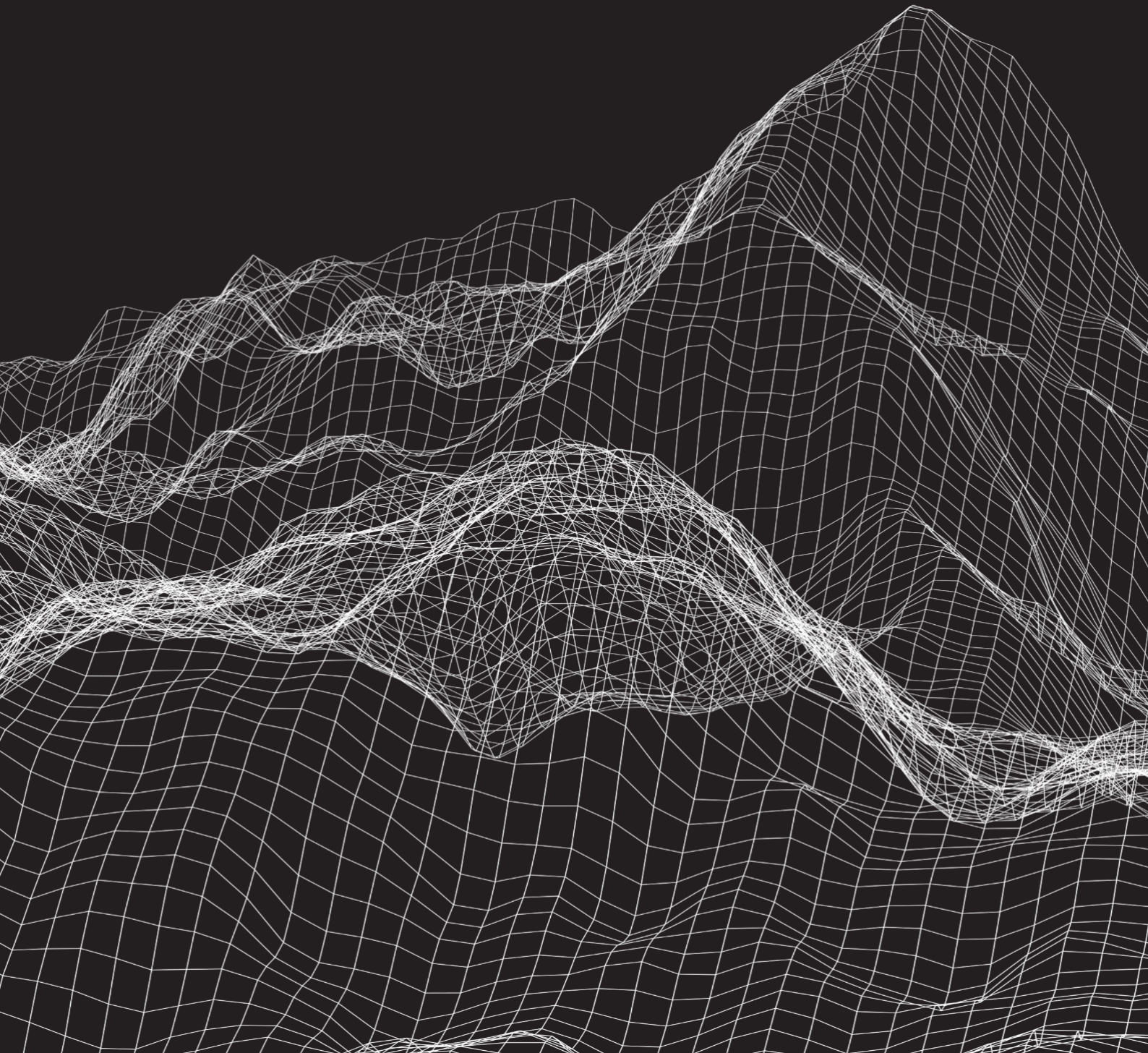

We are designing and manufacturing alarm messaging equipment for security companies that are looking to use new communications solutions and gain a technological edge.

**UAB TRIKDIS** was established in 1996 as a joint initiative between scientists from Kaunas University of Technology and one of the first Lithuanian security companies “Jungtis”.

From there we grew to an independent company, working with both small and big security companies around the world.

**Our first VHF/UHF radio transmitters were created back in the year 2000.**

Most of them are still in use for transmitting signals from various secured objects. Using the experience and knowledge we've gathered through years, we developed cellular and Internet (Ethernet) communicators with more advanced features.



# G16

The G16 connects to compatible DSC, Paradox, UTC Interlogix (CADDX), Innerrange, Texecom, Honeywell, Crow and Pyronix alarm panels.

Also its perfect tool to remotely monitor and control devices and systems to detect faults and malfunctions in seconds to minimise downtime and maximise services efficient

## Reliable communication:



- communication with two different CMS at same time
- +backup channels
- \*reported to CMS with SMS messages when IP connection stops.
- Supervision heartbeats

## Fast and easy setup



- USB connector for setup via PC.
- Slot for SIM card of any GSM operator
- Control by Protegus 2 mobile app.
- \*Control by SMS.

## Controllable outputs and inputs:



- 3 double I/O terminals
- Add additional inputs and controllable outputs with iO-8 expanders.





highest EN50131

## SPECIFICATIONS ▼

Connects to panel	Serial or keypad bus
Dual purpose terminals [IN/OUT]	3, can be set as either NC; NO; NC/EOL; NO/EOL; NC/DEOL; NO/DEOL (2,2 kΩ) type inputs or open collector (OC) type outputs with current up to 0,15 A, 30 VDC max. Expandable with iO-8 series expanders.
LTE FDD	B1/B2/B3/B4/B5/B7/B8/B12/B13/B18/B19/B20/B25/B26/B28
LTE TDD	B38/B39/B40/B41
UMTS	B1/B2/B4/B5/B6/B8/B19
GSM	850/900/1800/1900 MHz
Power supply voltage	10-18 V DC
Current consumption	60-100 mA (on standby) Up to 500 mA (while sending data)
Transmission protocols	TRK, DC-09_2007, DC-09_2012, TL150
Message encryption	AES 128
Changing settings	With TrikdisConfig computer program remotely or locally via USB Mini-B port Remotely with SMS messages
Operating environment	Temperature from -10 °C to +50 °C, relative humidity - up to 80% at +20 °C
Communicator dimensions	92 x 62 x 26 mm
Weight	80 g

## COMPATIBILITY ▼

Manufacturer	Model
DSC®	<b>PC585</b> , PC1404, <b>PC1565</b> , <b>PC1616</b> , <b>PC1832</b> , <b>PC1864</b> , PC5015, PC5020
PARADOX®	<b>SPECTRA SP4000</b> , <b>SP5500</b> , <b>SP6000</b> , <b>SP7000</b> , <b>SP65</b> , <b>SP5500+</b> , <b>SP6000+</b> , <b>SP7000+</b>
	<b>MAGELLAN MG5000</b> , <b>MG5050</b> , <b>MG5050E</b> , <b>MG5075</b> , <b>MG5050+</b>
	<b>DIGIPLEX EVO48</b> , <b>EVO192</b> , <b>EVOHD</b> , NE96, <b>EVO96</b>
UTC Interlogix®	SPECTRA 1727, 1728, 1738
	ESPRIT E55, 728ULT, 738ULT
UTC Interlogix®	<b>NetworX (Caddx) NX-4v2</b> , <b>NX-6v2</b> , <b>NX-8v2</b> , <b>NX-8e</b>
Texecom®	<b>Premier 24</b> , <b>48</b> , <b>88</b> , <b>168</b> <b>Premier Elite 12</b> , <b>24</b> , <b>48</b> , <b>64</b> , <b>88</b> , <b>168</b>
Pyronix®	MATRIX 424, MATRIX 832, MATRIX 832+, MATRIX 6, MATRIX 816
Innerrange®	Inception
Honeywell®	<b>Ademco Vista-15</b> , <b>Ademco Vista-20</b> , <b>Ademco Vista-48</b>
Crow®	Runner 4/8, 8/16

\*Red – remote Arm/Disarm via Serial bus

\*\* Communicator is compatible with other manufacturer control panels when connected with GSM communicators G16T

# UNIFYING TIP RING AND SERIAL BUS. FOR SEAMLESS CONNECTIVITY

# TEG



CELLULAR COMMUNICATOR

**Savor the Best: G16 and G16T, United in GT**  
 Introducing the GT Cellular Communicator, where innovation meets reliability in the realm of security. Connect effortlessly through either TIP RING or Serial BUS to your control panel, offering you flexible options.

This module seamlessly combines the best features of the renowned G16 and G16T, culminating in a security solution that's as robust as it is efficient.

Fast installation is at the heart of our design, ensuring you experience swift setup without compromising on security. With GT, we've united the strengths of our exceptional predecessors to deliver a security solution that sets a new standard for the industry.

### Dual Connectivity

Seamlessly connect via TIP RING or Serial BUS, choose the option that suits your needs.

### Instant Device Integration

One-Click Magic! Scan Device QR and Assign to Monitoring Center. Adding devices has never been this effortless. Say goodbye to manual receiver entries, and say hello to seamless, automated direction to the right monitoring center software via Protegus 2 Company.

### Reliable Communication

GT+ ensures messages from security panel reach the Central Monitoring Station swiftly, giving you the peace of mind you deserve.

### Universal Compatibility

Compatible with leading security alarm panels from various manufacturers.

### Multi-Channel Alerts

Stay informed through multiple channels, including Protegus 2 app notifications and more.

### Flexible I/O Terminals

Enjoy 2 double I/O terminals that can be configured as input or controllable output.

### Remote Control and Updates

Stay up to date with remote configuration and firmware updates.

### Sends events to monitoring station receiver:

- Sends events to TRIKDIS software or hardware receivers that work with any monitoring software.
- Can send event messages to SIA DC-09 receivers.
- Can send event messages to SUR-GARD receivers.
- Connection supervision by polling to IP receiver every 30 seconds (or by user defined period).
- Backup channel, that will be used if connection with the primary channel is lost.
- When Protegus 2 service is enabled, events are first delivered to CMS, and only then are sent to app users.

### Works with Protegus 2 app:

- “Push” and special sound notifications informing about events.
- Remote system Arm/Disarm.
- Remote control of connected devices (lights, gates, ventilation systems, heating, sprinklers, etc.).
- Different user rights for administrator, installer and user.
- Users can be notified about events with Protegus 2 app.

### Controllable outputs and inputs:

- 2 double I/O terminals that can be set either as input (IN) or controllable output (OUT).
- Connect your security panel via serial bus or landline dialer (TIP RING contacts).
- Add additional inputs and controllable outputs with iO-8 expanders.

### Practical setup:

- Flexible Integration. Connect with ease to your control panel, giving you the freedom to choose the connection method via TIP RING or Serial BUS, choose the option that suits your needs.
- Automated direction to the monitoring center.
- Settings can be saved to file or in Protegus 2 company account and quickly written to other communicators.
- Two access levels for configuring the device for CMS administrator and for installer.
- Remote configuration and firmware updates.

Dual purpose terminals [IN/OUT]	2, can be set as either NC; NO; NC/EOL; NO/EOL; NC/DEOL; NO/DEOL (2,2 kΩ) type inputs or open collector (OC) type outputs with current up to 0,15 A, 30 VDC max.  Expandable with iO-8 expanders.
Modem EG915U-EU (Europe)	<b>LTE FDD:</b> B1/B3/B5/B7/B8/B20/B28
	<b>GSM:</b> B2/B3/B5/B8
Modem EG915U-LA (Latin America)	<b>LTE FDD:</b> B2/B3/B4/B5/B7/B8/B28/B66
	<b>GSM:</b> B2/B3/B5/B8
Modem BG95-M5 (Cat M1)	<b>LTE-FDD:</b> B1/B2/B3/B4/B5/B8/B12/B13/B18/B19/B20/B25/B26/B27/B28/B66/B85
	<b>EGPRS:</b> 850/900/1800/1900 MHz
Power supply voltage	10-32 V DC
Current consumption	125 mA
Transmission protocols	TRK8, DC-09_2007, DC-09_2012
Message encryption	AES 128
Changing settings	With Protegus 2 app remotely or TrikidisConfig PC program remotely or locally via USB-C port
Operating environment	Temperature from -10 °C to 50 °C, relative humidity - up to 80% at +20 °C
Communicator dimensions	92 x 62 x 26 mm
Weight	80 g

Manufacturer	Model
DSC®	<b>PC585, PC1404, PC1565, PC1616, PC1832, PC1864, PC5015, PC5020</b>
PARADOX®	<b>SPECTRA SP4000, SP5500, SP6000, SP7000, SP65, SP5500+, SP6000+, SP7000+</b>
	<b>MAGELLAN MG5000, MG5050, MG5050E, MG5075, MG5050+</b>
	<b>DIGIPLEX EVO48, EVO192, EVOHD, NE96, EVO96</b> SPECTRA 1727, 1728, 1738 ESPRIT E55
UTC Interlogix®	<b>NetworX (Caddx) NX-4v2, NX-6v2, NX-8v2, NX-8e</b>
Texecom®	<b>Premier 24, 48, 88, 168</b> <b>Premier Elite 12, 24, 48, 64, 88, 168</b> Premier 412, 816, 832, 832+
Honeywell®	<b>Ademco Vista-15, Ademco Vista-20, Ademco Vista-48</b>

\*Red – Connects via SERIAL or KEYPAD bus for remote security system control/monitoring.

\*\*Black – Connects via SERIAL or KEYPAD bus for remote alarm monitoring.

# WHERE TIP RING AND SERIAL BUS UNITE.

UNIVERSAL COMPATIBILITY WITHOUT BOUNDARIES

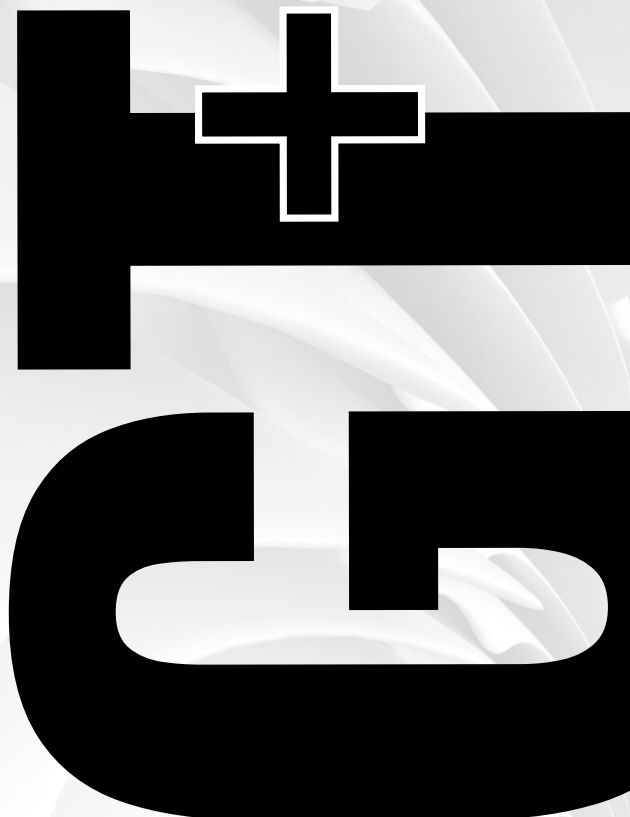

## Where SIA FSK Meets Unparalleled Reliability.

Introducing the GT+ Cellular Communicator, surpassing the excellence of the GT, where innovation harmonizes with reliability in the world of security, fully supporting the SIA FSK protocol. Effortlessly connect via either TIP RING or Serial BUS to your control panel, providing you with superior and versatile connectivity options.

This module seamlessly fuses the standout features of the esteemed G16 and G16T, resulting in a security solution that is as robust as it is efficient.

At the core of our design is swift installation, ensuring you can set up your system quickly without compromising security. With GT+, we've harnessed the strengths of our exceptional predecessors to deliver a security solution that raises the industry standard, all while supporting SIA FSK protocol.

### SIA FSK Protocol Support

Fully supports the SIA FSK protocol for enhanced communication and data transmission.

### Dual Connectivity

Seamlessly connect via TIP RING or Serial BUS, choose the option that suits your needs.

### Instant Device Integration

One-Click Magic! Scan Device QR and Assign to Monitoring Center. Adding devices has never been this effortless. Say goodbye to manual receiver entries, and say hello to seamless, automated direction to the right monitoring center software via Protegus 2 Company.

### Reliable Communication

GT+ ensures messages from security panel reach the Central Monitoring Station swiftly, giving you the peace of mind you deserve.

### Universal Compatibility

Compatible with leading security alarm panels from various manufacturers.

### Multi-Channel Alerts

Stay informed through multiple channels, including Protegus 2 app notifications and more.

### Flexible I/O Terminals

Enjoy 2 double I/O terminals that can be configured as input or controllable output.

### Remote Control and Updates

Stay up to date with remote configuration and firmware updates.

### Sends events to monitoring station receiver:

- Sends events to TRIKDIS software or hardware receivers that work with any monitoring software.
- Can send event messages to SIA DC-09 receivers.
- Connection supervision by polling to IP receiver every 30 seconds (or by user defined period).
- Backup channel, that will be used if connection with the primary channel is lost.
- When Protegus 2 service is enabled, events are first delivered to CMS, and only then are sent to app users.

### Works with Protegus 2 app:

- “Push” and special sound notifications informing about events.
- Remote system Arm/Disarm.
- Remote control of connected devices (lights, gates, ventilation systems, heating, sprinklers, etc.).
- Different user rights for administrator, installer and user.
- Users can be notified about events with Protegus 2 app.

### Controllable outputs and inputs:

- 2 double I/O terminals that can be set either as input (IN) or controllable output (OUT).
- Connect your security panel via serial bus or landline dialer (TIP RING contacts).
- Add additional inputs and controllable outputs with iO-8 expanders.

### Practical setup:

- Flexible Integration. Connect with ease to your control panel, giving you the freedom to choose the connection method via TIP RING or Serial BUS, choose the option that suits your needs.
- Automated direction to the monitoring center.
- Settings can be saved to file or in Protegus 2 company account and quickly written to other communicators.
- Two access levels for configuring the device for CMS administrator and for installer.
- Remote configuration and firmware updates.

Dual purpose terminals [IN/OUT]	2, can be set as either NC; NO; NC/EOL; NO/EOL; NC/DEOL; NO/DEOL (2,2 kΩ) type inputs or open collector (OC) type outputs with current up to 0,15 A, 30 VDC max.  Expandable with iO-8 expanders.
Modem EG915U-EU (Europe)	<b>LTE FDD:</b> B1/B3/B5/B7/B8/B20/B28
	<b>GSM:</b> B2/B3/B5/B8
Modem EG915U-LA (Latin America)	<b>LTE FDD:</b> B2/B3/B4/B5/B7/B8/B28/B66
	<b>GSM:</b> B2/B3/B5/B8
Modem BG95-M5 (Cat M1)	<b>LTE-FDD:</b> B1/B2/B3/B4/B5/B8/B12/B13/B18/B19/B20/B25/B26/B27/B28/B66/B85
	<b>EGPRS:</b> 850/900/1800/1900 MHz
Power supply voltage	10-32 V DC
Current consumption	125 mA
Transmission protocols	TRK8, DC-09_2007, DC-09_2012
Message encryption	AES 128
Changing settings	With Protegus 2 app remotely or TrikidisConfig PC program remotely or locally via USB-C port
Operating environment	Temperature from -10 °C to 50 °C, relative humidity - up to 80% at +20 °C
Communicator dimensions	92 x 62 x 26 mm
Weight	80 g

Manufacturer	Model
DSC®	<b>PC585, PC1404, PC1565, PC1616, PC1832, PC1864, PC5015, PC5020</b>
PARADOX®	<b>SPECTRA SP4000, SP5500, SP6000, SP7000, SP65, SP5500+, SP6000+, SP7000+</b>
	<b>MAGELLAN MG5000, MG5050, MG5050E, MG5075, MG5050+</b>
	<b>DIGIPLEX EVO48, EVO192, EVOHD, NE96, EVO96</b>
	SPECTRA 1727, 1728, 1738  ESPRIT E55
UTC Interlogix®	<b>NetworX (Caddx) NX-4v2, NX-6v2, NX-8v2, NX-8e</b>
Texecom®	<b>Premier 24, 48, 88, 168 Premier Elite 12, 24, 48, 64, 88, 168 Premier 412, 816, 832, 832+</b>
Honeywell®	<b>Ademco Vista-15, Ademco Vista-20, Ademco Vista-48</b>

\*Red – Connects via SERIAL or KEYPAD bus for remote security system control/monitoring.

\*\*Black – Connects via SERIAL or KEYPAD bus for remote alarm monitoring.

# LAN or SIM? TIP RING or Serial BUS?

Many Ways, One Solution

Don't settle for a one-dimensional security system. The GET Security Communicator gives you multiple paths to stay informed and in control. Get real-time notifications through the Protegus 2 app.



CELLULAR AND ETHERNET COMMUNICATOR

## GET CONNECTED, STAY PROTECTED



### Multi-Platform Event Reporting

Can send events to multiple receivers, including TRIKDIS software/hardware and SIA DC-09 receivers.

### Reliable Communication

Automatic LTE/LAN Switch & Back-Up Channel with Connection Supervision for Reliable Event Delivery.

### Serial Bus or Landline Options

Connect your security panel via serial bus or landline dialer (TIP RING contacts).

### User-Friendly App Integration

Works seamlessly with the Protegus 2 app, providing "push" and sound notifications, remote system arm/disarm and control of connected devices.

### Practical Configuration

Settings can be saved to file and quickly written to other communicators, and the device can be remotely configured and updated with firmware.

### Sends events to monitoring station receiver:

- Sends events to TRIKDIS software or hardware receivers that work with any monitoring software.
- Or can send event messages to SIA DC-09 receivers.
- Connection supervision by polling to IP receiver every 30 seconds (or by user defined period).
- Backup channel or communication technology (such as LTE or LAN), that will be used if connection with the primary channel is lost.
- When Protegus 2 service is enabled, events are first delivered to CMS, and only then are sent to app users.

### Works with Protegus 2 app:

- “Push” and special sound notifications informing about events.
- Remote system Arm/Disarm.
- Remote control of connected devices (lights, gates, ventilation systems, heating, sprinklers, etc.).
- Different user rights for administrator, installer and user.

### Controllable outputs and inputs:

- 2 I/O, selectable type

### Practical setup:

- Flexible Integration. Connect with ease to your control panel, giving you the freedom to choose the connection method via TIP RING or Serial BUS, choose the option that suits your needs.
- Settings can be saved to file and quickly written to other communicators.
- Two access levels for configuring the device for CMS administrator and for installer.
- Remote configuration and firmware updates.

Connects to panel	Serial or Keypad Bus, or Landline dialer (TIP RING contacts)
Dual purpose terminals [IN/OUT]	2 selectable type: <b>Inputs:</b> NC/NO; NC/EOL; NO/EOL; NC/DEOL; NO/DEOL <b>Outputs:</b> OC type, up to 0,15 A, 30 V max
Ethernet connection	IEEE802.3, 10 Base-T, RJ45 socket
Modem EG915U-EU (Europe)	<b>LTE FDD:</b> B1/B3/B5/B7/B8/B20/B28 <b>GSM:</b> B2/B3/B5/B8
Modem EG915U-LA (Latin America)	<b>LTE FDD:</b> B2/B3/B4/B5/B7/B8/B28/B66 <b>GSM:</b> B2/B3/B5/B8
Modem BG95-M5 (Cat M1)	<b>LTE-FDD:</b> B1/B2/B3/B4/B5/B8/B12/B13/B18/B19/B20/B25/B26/B27/B28/B66/B85 <b>EGPRS:</b> 850/900/1800/1900 MHz
Power supply voltage	10-18 V DC
Current consumption	Up to 100 mA (on standby) Up to 250 mA (while sending data)
Transmission protocols	TRK8, DC-09_2007, DC-09_2012
Message encryption	AES 128
Memory	Up to 60 messages
Changing settings	With Protegus 2 app remotely or TrikdisConfig PC program remotely or locally via USB-C port
Operating environment	Temperature from -10 °C to 50 °C, relative humidity - up to 80% at +20 °C
Communicator dimensions	113 x 70 x 25mm
Weight	110 g

Manufacturer	Model
DSC®	<b>PC585, PC1404, PC1565, PC1616, PC1832, PC1864, PC5015, PC5020</b>
PARADOX®	<b>SPECTRA SP4000, SP5500, SP6000, SP7000, SP65, SP5500+, SP6000+, SP7000+</b> <b>MAGELLAN MG5000, MG5050, MG5050E, MG5075, MG5050+</b> <b>DIGIPLEX EVO48, EVO192, EVOHD, NE96, EVO96</b> SPECTRA 1727, 1728, 1738 ESPRIT E55
UTC Interlogix®	<b>NetworX (Caddx) NX-4v2, NX-6v2, NX-8v2, NX-8e</b>
Texecom®	<b>Premier 24, 48, 88, 168</b> <b>Premier Elite 12, 24, 48, 64, 88, 168</b> Premier 412, 816, 832, 832+
Honeywell®	<b>Ademco Vista-15, Ademco Vista-20, Ademco Vista-48</b>

\*Red – Connects via SERIAL or KEYPAD bus for remote security system control/monitoring.

\*\*Black – Connects via SERIAL or KEYPAD bus for remote alarm monitoring.

# G16T



## CELULAR COMMUNICATOR

▼ CELLULAR COMMUNICATOR



### Universal

Connects to any alarm panel which has a landline dialer. Supports full transmission Contact ID, SIA or 4+2 event information to security company's monitoring station.



### Supervised connection

Polling of the connection as often as 30 seconds.



### Works with Protegus 2 app

Users can arm/disarm their alarm system remotely and receive notifications about events.

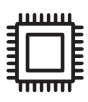

### 5G ready

Can be ordered with 4G (CatM1 - Narrowband) cellular modems.



### Grade 4 Certified

Certified to the highest EN50131 Grade 4 security rating.

### **Sends events to monitoring station receiver:**

- Sends events to TRIKDIS software or hardware receivers that work with any monitoring software.
- Can send event messages to SIA DC-09 receivers.
- Connection supervision by polling to IP receiver every 30 seconds (or by user defined period).
- Backup channel, that will be used if connection with the primary channel is lost.
- Events can be reported to CMS with SMS messages. SMS will be sent even if data connection stops working in the mobile operator network.
- With parallel communication channels, events can be sent to two receivers at same time.
- When Protegus 2 service is enabled, events are first delivered to CMS, and only then are sent to app users.

### **Works with Protegus 2 app:**

- "Push" and special sound notifications informing about events.
- Remote system Arm/Disarm.
- Remote control of connected devices (lights, gates, ventilation systems, heating, sprinklers, etc.).
- Different user rights for administrator, installer and user.

### **Notifies users:**

- Users can be notified about events not only with Protegus 2 app, but also with SMS messages and a call.

### **Controllable outputs and inputs:**

- 3 I/O, selectable type: NC; NO; NC/EOL; NO/EOL; NC/DEOL; NO/DEOL.
- Add additional inputs and controllable outputs with iO-8 expanders.

### **Quick setup:**

- Settings can be saved to file and quickly written to other communicators.
- Two access levels for configuring the device for CMS administrator and for installer.
- Remote configuration and firmware updates.

Connects to panel	Landline dialer (TIP RING contacts)
Dual purpose terminals [IN/OUT]	3, can be set as either NC; NO; NC/EOL; NO/EOL; NC/DEOL; NO/DEOL (10 kΩ) type inputs or open collector (OC) type outputs with current up to 0,15 A, 30 VDC max. Expandable with iO-8 expanders.
LTE FDD	B1/B2/B3/B4/B5/B8/B12/B13B18/B19/B20/B25/B28
LTE TDD	B39 (only Cat M1)
Cat M1/Cat NB1	B1/B2/B3/B4/B5/B8/B12/B13B18/B19/B20/B25/B28
GSM	850 / 900 / 1800 /1900 MHz
Power supply voltage	10-18 V DC
Current consumption	60-100 mA (on standby) Up to 250 mA (while sending data)
Transmission protocols	TRK, DC-09_2007, DC-09_2012, TL150
Message encryption	AES 128
Changing settings	With TrikdisConfig computer program remotely or locally via USB Mini-B port Remotely with SMS messages
Operating environment	Temperature from -10 °C to 50 °C, relative humidity - up to 80% at +20 °C
Communicator dimensions	92 x 62 x 26 mm
Weight	80 g

# E16



## ETHERNET COMMUNICATOR



### ETHERNET COMMUNICATOR



#### Full event information

Communicator transmits full event information to the Central Monitoring Station.



#### Panel integration

Connects to supported panel's serial or keypad bus. This allows the communicator to read and retransmit panel events in less than 1 second.



#### Stable connection

Ethernet connection delivers a consistently solid connection, lower latency. Ethernet is more reliable in terms of interference.



#### Works with Protegus 2 app

Users can arm/disarm their alarm system remotely and receive notifications about events.

**E16 is not just an Ethernet transmitter that sends messages to compatible security systems. It also transmits the command received over the internet to the system to arm/disarm protection mode.**

#### **Sends events to monitoring station receiver:**

- Sends events to TRIKDIS software or hardware receivers that work with any monitoring software.
- Can send event messages to SIA DC-09 receivers.
- Frequent connection checks/control in order to quickly detect connection loss.
- Backup channel, that will be used if connection with the primary channel is lost.
- With parallel communication channels events can be sent to two receivers at same time.
- When Protegus 2 service is enabled, events are first delivered to CMS, and only then are sent to app users.

#### **Works with Protegus 2 app:**

- “Push” and special sound notifications informing about events.
- Remote system Arm/Disarm.
- Remote control of connected devices (lights, gates, ventilation systems, heating, sprinklers, etc.).
- Different user rights for administrator, installer and user.

#### **Notifies users:**

- Users can be notified about events with Protegus 2 app.

#### **Controllable outputs and inputs:**

- 3 double I/O terminals that can be set either as input (IN) or controllable output (OUT) terminals.
- Outputs controlled by the Protegus 2 app.
- Add additional inputs and controllable outputs with wired and wireless iO expanders.

#### **Quick setup:**

- Settings can be saved to file and quickly written to other communicators.
- Two access levels for configuring the device for CMS administrator and for installer.
- Remote configuration and firmware updates.

## **Specifications:**

Dual purpose terminals [IN/OUT]	3, can be set as either NC; NO; NC/EOL; NO/EOL; NC/DEOL; NO/DEOL (2,2 kΩ) type inputs or open collector (OC) type outputs with current up to 0,15 A, 30 VDC max. Expandable with iO series expanders.
Power supply voltage	10-18 V DC
Current consumption	100 mA (on standby) Up to 250 mA (while sending data)
Ethernet connection	IEEE802.3, 10 Base-T, RJ45 socket
Transmission protocols	TRK, DC-09_2007, DC 09_2012
Memory	Up to 60 messages
Message encryption	AES 128
Changing settings	With TrikdisConfig computer program remotely or locally via USB Mini-B port
Operating environment	Temperature from -10 °C to 50 °C, relative humidity - up to 80% at +20 °C
Communicator dimensions	88 x 62 x 26 mm
Weight	80 g

## **Supported intrusion alarm panels:**

Manufacturer	Model
DSC®	<b>PC585</b> , PC1404, <b>PC1565</b> , <b>PC1616</b> , <b>PC1832</b> , <b>PC1864</b> , PC5015, PC5020
PARADOX®	<b>SPECTRA SP4000</b> , <b>SP5500</b> , <b>SP6000</b> , <b>SP7000</b> , <b>SP65</b> , <b>SP5500+</b> , <b>SP6000+</b> , <b>SP7000+</b> <b>MAGELLAN MG5000</b> , <b>MG5050</b> , <b>MG5050E</b> , <b>MG5075</b> , <b>MG5050+</b> <b>DIGIPLEX EVO48</b> , <b>EVO192</b> , <b>EVOHD</b> , NE96, <b>EVO96</b> SPECTRA 1727, 1728, 1738 ESPRIT E55, 728ULT, 738ULT
UTC Interlogix®	<b>NetworX (Caddx) NX-4v2</b> , <b>NX-6v2</b> , <b>NX-8v2</b> , <b>NX-8e</b>
Texecom®	<b>Premier 24</b> , <b>48</b> , <b>88</b> , <b>168</b> <b>Premier Elite 12</b> , <b>24</b> , <b>48</b> , <b>64</b> , <b>88</b> , <b>168</b>
Pyronix®	MATRIX 424, MATRIX 832, MATRIX 832+, MATRIX 6, MATRIX 816
Innerrange®	Inception
Honeywell®	<b>Ademco Vista-15</b> , <b>Ademco Vista-20</b> , <b>Ademco Vista-48</b>
Crow®	Runner 4/8, 8/16

\*Red – remote Arm/Disarm via Serial bus

\*\* Communicator is compatible with other manufacturer control panels when connected with GSM communicators E16T

# E16T



## ETHERNET COMMUNICATOR



### ETHERNET COMMUNICATOR



#### Universal

Connects to any alarm panel that has a landline dialer and supports dialing in Contact ID protocol and DTMF tones. Transmits full Contact ID event information to security company's monitoring station.



#### Supervised connection

Polling of the connection as often as 10 seconds.



#### Works with Protegus 2 app

Customers are informed about security system events in Protegus 2 app. They can Arm/Disarm the alarm system remotely via panel's keyswitch zone.

### Sends events to monitoring station receiver:

- Sends events to TRIKDIS software or hardware receivers that work with any monitoring software.
- Can send event messages to SIA DC-09 receivers.
- Connection supervision by polling to IP receiver every 10 seconds (or by user defined period).
- Backup channel, that will be used if connection with the primary channel is lost.
- When Protegus 2 service is enabled, events are first delivered to CMS, and only then are sent to app users.

### Works with Protegus 2 app:

- “Push” and special sound notifications informing about events.
- Remote system Arm/Disarm.
- Remote control of connected devices (lights, gates, ventilation systems, heating, sprinklers, etc.).
- Different user rights for administrator, installer and user.

### Controllable outputs and inputs:

- 3 I/O, selectable type: NC, NO, EOL=2.2 kΩ

### Quick setup:

- Settings can be saved to file and quickly written to other communicators.
- Two access levels for configuring the device for CMS administrator and for installer.
- Remote configuration and firmware updates.

## Supported intrusion alarm panels:

Any alarm panel that has a landline dialer and supports dialing in Contact ID protocol and DTMF tones.

Power supply voltage	10 - 15 VDC
Current consumption	100 mA (on standby) Up to 250 mA (while sending data)
Ethernet connection	IEEE802.3, 10 Base-T, RJ45 socket
Connection to control panel	Via Telephone Communicator (TIP RING terminals)
Dual purpose terminals [IN/OUT]	3, can be set as either NC; NO; NC/EOL; NO/EOL; NC/DEOL; NO/DEOL (10 kΩ) type inputs or open collector (OC) type outputs with current up to 0,15 A, 30 VDC max. Expandable with iO series expanders
Transmission protocols	TRK, DC-09_2007, DC-09_2012, TL150
Message encryption	AES 128
Changing settings	With TrikdirConfig computer program remotely or locally via USB Mini-B port
Memory	Up to 60 messages
Operating environment	Temperature from -10 °C to 50 °C, relative humidity - up to 80% at +20 °C
Communicator dimensions	88 x 62 x 26 mm
Weight	0.08 kg

Designed to combine the best features of TRIKDIS security control panels, communicators and controllers.

- Wi-Fi +4G
- Wi-Fi +2G
- Ethernet +4G
- +Ethernet
- Wi-Fi

FLEXi is a hybrid security control panel with on-board WiFi and Cellular or Ethernet connectivity. Unique feature set allows you to use this panel both in intrusion alarm and automation installations.

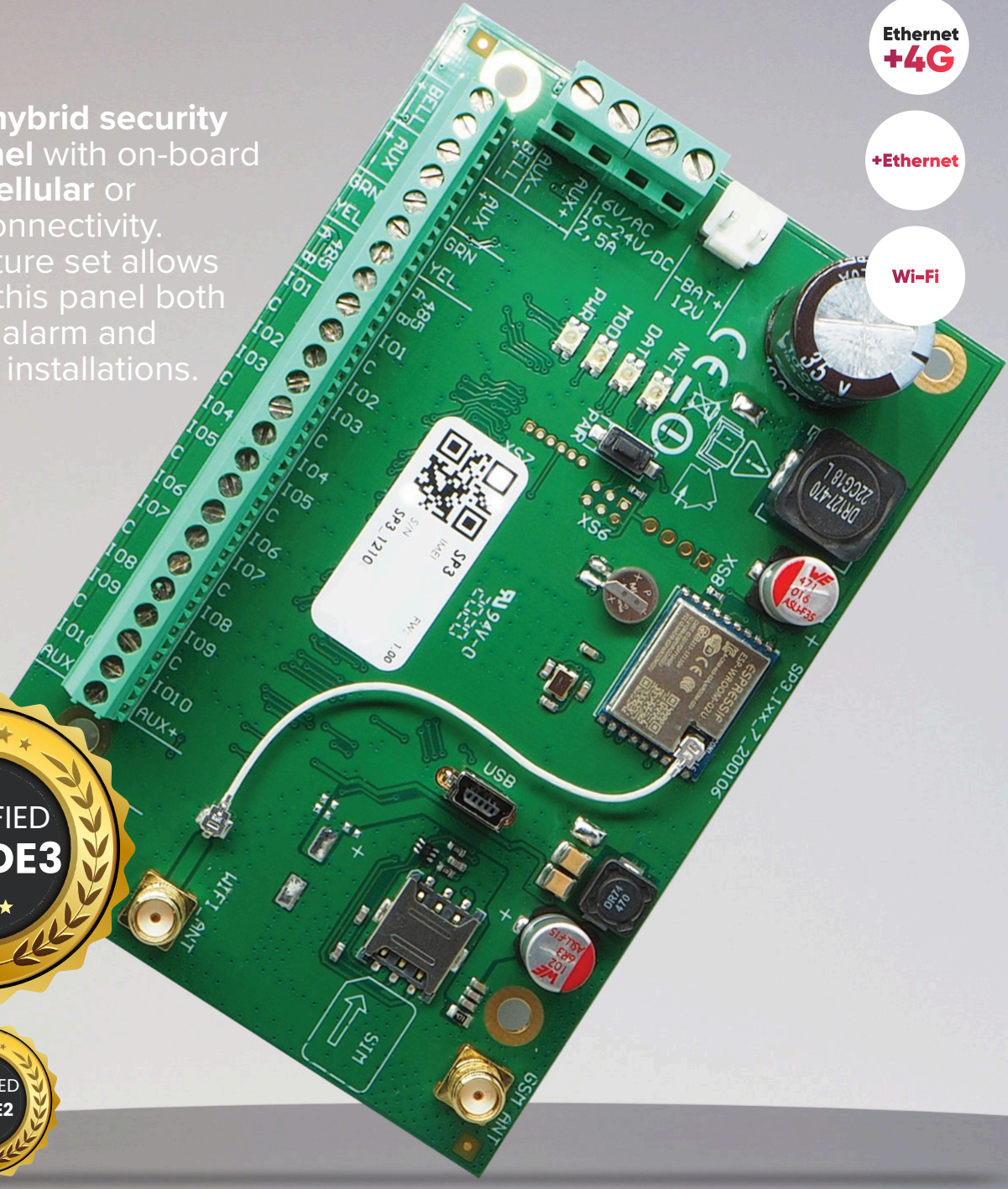

SECURITY CONTROL PANEL



# FLEXi SP3

Adaptable Security Panel

# Modifications

Tailored to individual cases, different connection requirements, and **meets different user needs** so you will make a great solution every time.

Power supply	16-24 V, 2,5 A AC
Current consumption	Up to 50 mA (stand-by), Up to 200 mA (short-term, while sending)
WiFi frequency, protocol, encryption	2,4 GHz, 802.11 b/g/n, WPA, WPA2, WPA mixed
WiFi network configuration	DHCP or manual
SIM card	1, NANO size
GSM/GPRS modem	Quad-band
4G modem	4G (LTE-FDD) with migration to 3G (WCDMA) and 2G (GSM/EDGE) feature
Ethernet port	RJ-45 connector
Event transmission directions	- To main and backup receivers of 2 different security companies; - iOS/Android Protegus 2 mobiliąsias programas; - To 8 mobile phones via SMS messages. - Calls to 8 mobile phones. Vocal event notification
Event transmission channels	2G or 4G, WiFi, LAN (with module E485), SMS, Voice call, VHF/UHF radio (with transmitter T16)
Programmable communication channel/direction priority	Yes
Message encryption	TRK AES 128, SIA IP AES 128 / Contact ID codes
Internal clock	Yes
Events log memory	1000 entries, oldest deleted automatically
User codes	40
Duress code	Yes
No. of partitions	8
No. of zones	10 (20 if set ATZ), expandable up to 64
No. of PGM outputs	2 (12 if IO terminals are set as OUT) Expandable to 16 with expanders
No. of keypads	8
No. of RFID readers	2 (Wiegand 26/34)
No. of compatible temperature sensors	8
No. of compatible electronic (iButton) keys	40
Compatible wireless systems	M4, S8, via extra add-on RF module (Honeywell, Paradox)*
Operating environment	Temperature from -10 °C to +50 °C, relative humidity 80%, at +20 °C, no condensation

## Make It Wireless



Adding RF-M4 or RF-M8 enables wireless detector support for FLEXi SP3 — a clean, cable-free option that can be set up quickly through the app.

# WIRELESS SENSORS S8

Wireless security sensors for FLEXi systems

Designed to work seamlessly with FLEXi SP3, the S8 wireless sensors bring a new level of freedom to security installations. Every sensor is built to be discreet, easy to install and effortlessly reliable — combining smart design with dependable communication for day-to-day protection.

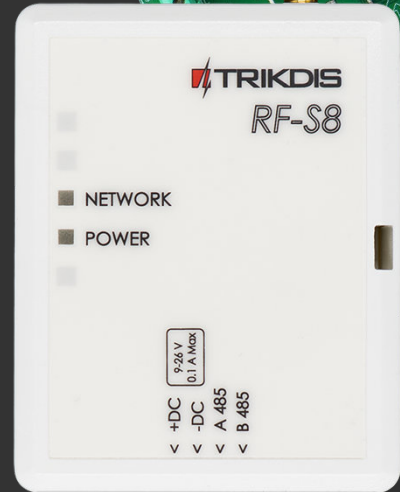

## RF-S8

Adds wireless sensor support to FLEXi SP3



## KEY FEATURES:

Wide selection of wireless sensors for complete protection – motion, smoke, door, water and more

Elegant, discreet design that fits any interior

Quick pairing and easy installation – no wiring, no hassle

Stable and secure communication with FLEXi SP3

Long-lasting battery operation with low maintenance

Reliable performance in everyday use and harsh conditions

Simple expansion of any system – add sensors as needed



Honeywell

# RF-HW WIRELESS EQUIPMENT RECEIVER

for Honeywell equipment up to 64 zones

The RF-HW wireless transceiver is designed to work with FLEXi SP3 and Honeywell wireless equipment. The transceiver is easy to connect to the FLEXi SP3 control panel and ensures a reliable and secure connection. The transceiver can be used with a variety of Honeywell protocol-enabled equipment, such as wireless sensors, including door, window, motion sensors, keypads, and more.

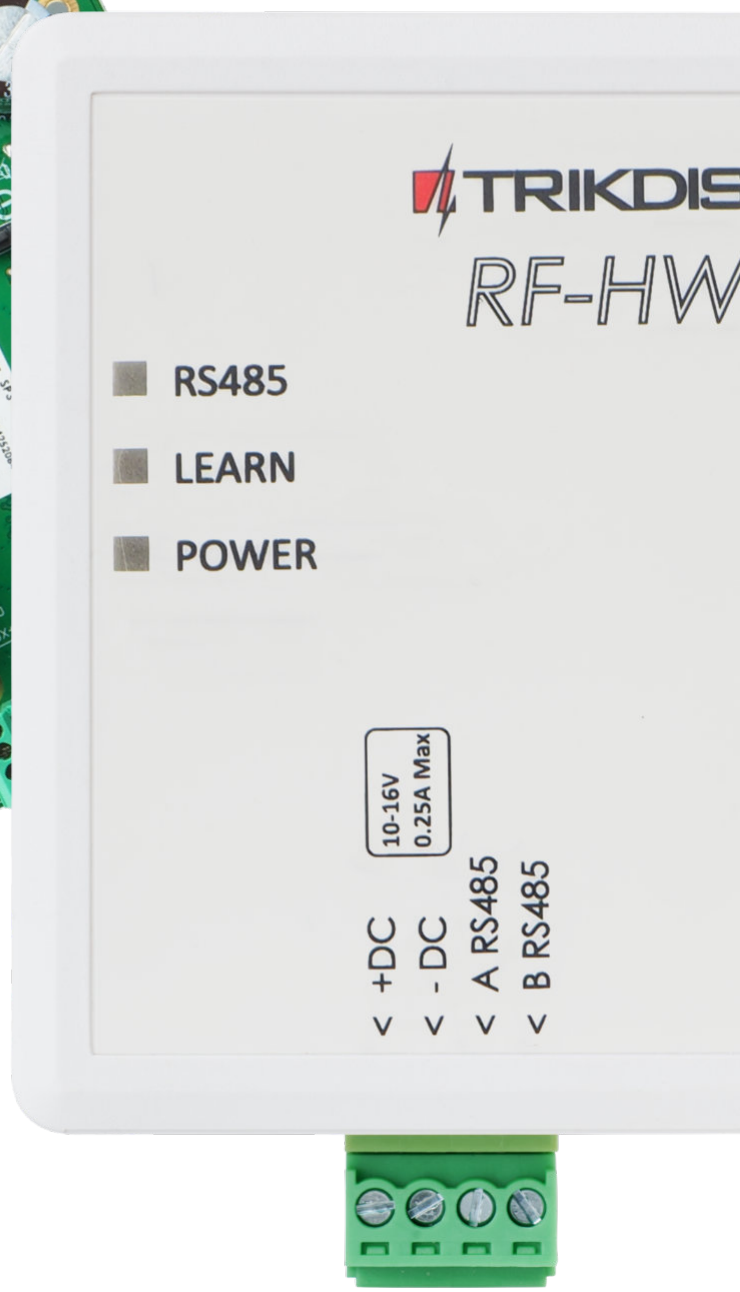

- No settings required**
- Compatible with Honeywell Home WL**
- RS485 interface**

- RS485
- LEARN
- POWER

10-16V  
0.25A Max

< +DC  
< - DC  
< A RS485  
< B RS485

# FLEXi KeyPad SK232 LED

Experience Security with a Glow

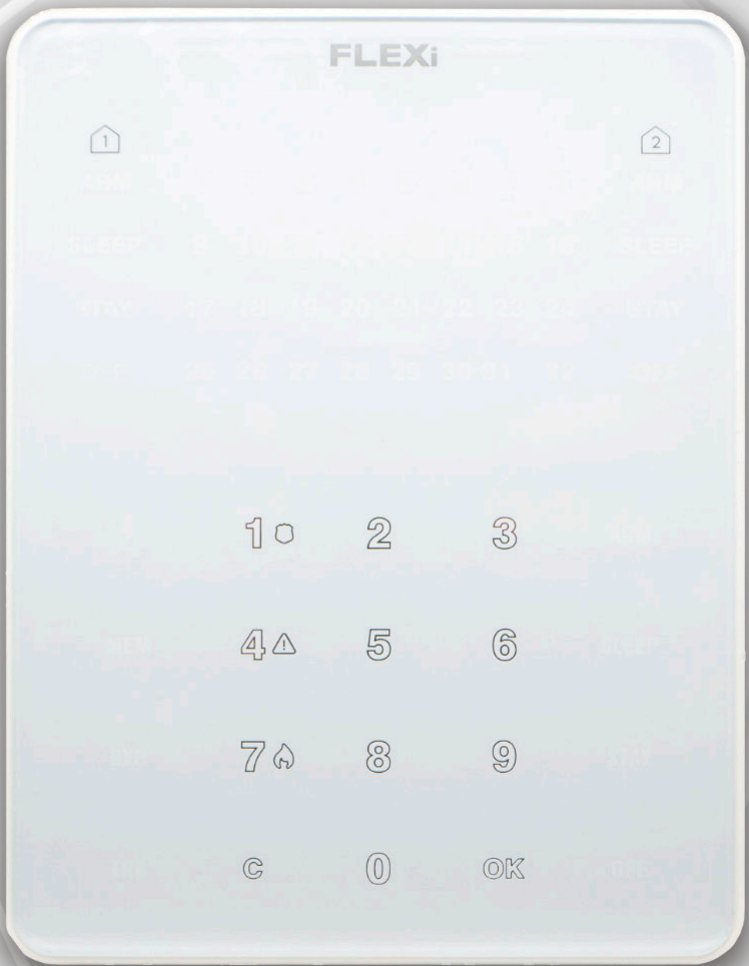

FLEXi's SK232 LED Keypad brings a touch of elegance and functionality to your security setup.



Introducing our sleek and minimalistic keypad with LED indication, purpose-built for the FLEXi SP3 control panel. It features backlit sensor touch buttons with tone feedback.

The FLEXi line stands as an flexible and versatile alarm system, carefully designed to flawlessly manage the security of home or business, effectively deterring potential intruders.

- White color
- Full LED indication for events in 32 zones
- 2 partition
- Touch-sensitive keys
- Panic codes
- Adjustable brightness and sound
- Automatic dimming
- Compatible with TRIKDIS control panel FLEXi SP3

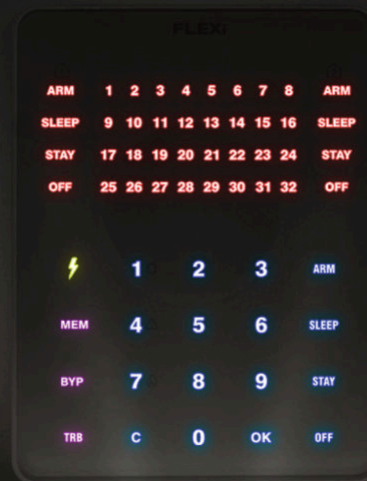

## SPECIFICATIONS ▼

Power supply	10-15 V DC
Power consumption	60 – 150 mA
Dimensions	152 x 115 x 22 mm
Weight	270 g

# FLEXi KeyPad SK LCD

Sleek minimalistic design keypad with LCD screen, designed for FLEXi SP3 control panel.





Sleek minimalistic design keypad with LCD screen, designed for FLEXi SP3 control panel. Backlit sensor touch buttons with tone. Multi-language support.

The FLEXi is a highly advanced, multifunction alarm control system, designed to flawlessly manage your security system at home or at business, protects you against burglary.

- White color
- LCD screen
- Indication for events in 32 zones
- 8 partitions
- Touch-sensitive keys
- Panic codes
- Adjustable brightness and sound
- Automatic dimming
- Temperature sensor
- Compatible with TRIKDIS control panel FLEXi SP3



## SPECIFICATIONS ▼

Power supply	10-15 V DC
Power consumption	25-60mA
Dimensions	152x117x22 mm
Weight	230 g

# FLEXi

KeyPad  
**SK-LED  
BUTTON**

The perfect solution for installers looking for a cost-effective, reliable, and user-friendly keypad tailored for the FLEXi SP3 system.



Designed exclusively for the FLEXi SP3 control panel, this keypad offers an affordable yet highly effective solution for managing security across multiple areas such as offices and retail spaces. Its intuitive design and customizable settings make it a valuable addition for any installer seeking to provide clients with a reliable and cost-efficient security upgrade.



- **Easy-to-Use Keypad:**

Intuitive design for hassle-free operation

- **Essential Functions:**

Trouble review, bypass activation, memory review

- **User Management:**

Add new users to the control panel directly via the keypad

- **Customizable Settings:**

Adjustable brightness and volume to suit your preferences

- **Reliable Performance:** Dependable operation in various environments

- **Energy-Saving Standby Mode:** Turn off the LED light at night for peace and comfort

## SPECIFICATIONS ▼

Power supply	10-15 V DC
Power consumption	<70mA
Dimensions	92x140x28.1 mm
Weight	150 g

# FLEXi

KeyPad  
**SK- LCD  
BUTTON**

User-friendly keypad designed for seamless integration with the FLEXi SP3 security control panel.



Specifically designed for the FLEXi SP3 control panel, this keypad provides a cost-effective and efficient solution for managing security in offices, retail spaces, and other multi-area environments. Featuring an LCD screen and an interface with intuitive icons instead of text, it ensures ease of use across different languages. Its customizable settings and user-friendly design make it an essential choice for installers seeking a reliable and versatile security upgrade.



- **Easy-to-Use Keypad:**  
Intuitive design for hassle-free operation
- **Essential Functions:**  
Trouble review, bypass activation, memory review
- **User Management:**  
Add new users to the control panel directly via the keypad
- **Customizable Settings:**  
Adjustable brightness and volume to suit your preferences
- **Reliable Performance:**  
Dependable operation in various environments
- **Energy-Saving Standby Mode:**  
Turn off the LED light at night for peace and comfort
- **Clear Visual Feedback:**  
Equipped with an informative LCD screen and intuitive icons for easy operation in any language
- **Versatile Coverage:**  
Supports up to 8 areas and 64 zones, providing comprehensive security for your property
- **Affordable and effective:**  
this keypad provides essential security features without breaking the bank.

## SPECIFICATIONS ▼

Power supply	10-15 V DC
Power consumption	<70mA
Inputs	1 EOL
Dimensions	92x140x28.1 mm
Weight	150 g

# GATE AUTOMATION CONTROLLER



## FEATURES:

Easy installation – only insert a SIM and connect the controller to device you want to control.

One 1A relay and two PGM outputs to:

- Control any device;
- Full and partial control of gates, or opening only doors.

Remote control with:

- Protegus 2 app (iOS, Android, Web);
- Phone call (cost-free, device rejects incoming calls);
- SMS messages.

Remote setup and administration – add users, and change settings with:

- TrikdisConfig;
- Protegus 2 app;
- SMS commands.

Send events to security company receiver.

WORKS WITH  
**protegus<sub>2</sub>**  
intelligent security & control





## ***SPECIFICATIONS:***

GSM	850 / 900 / 1800 / 1900 MHz
LTE FDD	B1/B3/B7/B8/B20/B28A
Power supply voltage	9-32 V DC 12-24 V AC
Current consumption	100 mA
Inputs	2, selectable type: NC, NO, EOL=10 kΩ
Universal inputs/outputs	2, can be set either as input IN with type: NC, NO, EOL=10 kΩ, or output OUT (open collector (OC) 50 mA)
Output	1, relay, 1 A 30 V DC, 0,5 A 125 V AC
Unsent events memory	Up to 60 events
Event log memory	Up to 5000 events
Users who receive messages and have permission to control	7
Users who have permission to control	1000
Operating environment	Temperature from -10 °C to 50 °C, relative humidity - up to 80% at +20 °C
Communicator dimensions	88 x 62 x 26 mm
Weight	0.08 kg

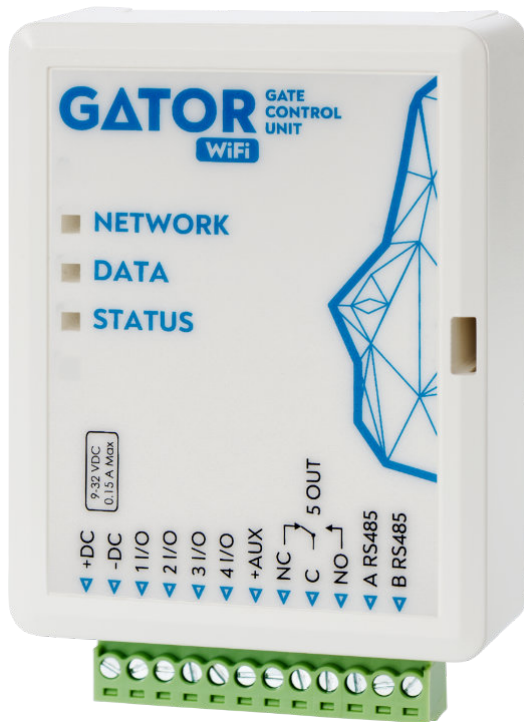

# WI-FI

## GATE AUTOMATION CONTROLLER

The Wi-Fi controller Gator is designed for remote control of an automatic door (or other electrical equipment).

Gator Wi-Fi can be controlled with Protegus 2 app. Up to 990 users.

Also can be used to set the user control schedule, set the counter, how many times the user can control the system. The controller can send messages about input and output activation and restores to the CMS (Central Monitoring Station) receiver and the Protegus 2 app.



# FEATURES

## Remote control

- With Mobile application Protegus 2.

## Messages for users

- Sends messages about events to the Protegus 2

## Messages for the security company

- Sends event information in Contact ID codes to TRIKDIS software and hardware receivers, which work with any monitoring software.
- Can simultaneously send event messages to the receiver of the safety company and work with the Protegus 2
- If the connection with the main receiver is lost, the messages are automatically sent to a backup receiver.

## Inputs and outputs

- 4 universal inputs/outputs. The mode of operation is set as either input (NO; NC; EOL) or output.
- 1 output (OUT) – relay.

## Settings and installation

- Quick and easy installation.
- The addition of new users and deletion of existing users can be done with the Protegus 2 app (when logged in with administrator rights), TrikdisConfig
- The device can be configured either by connecting a USB Mini-B cable or remotely with the TrikdisConfig and Protegus 2 app
- Remote updating of firmware.



# SPECIFICATIONS:

Power supply voltage	9-32 V DC
Current consumption	150 mA
Universal inputs/outputs	4, can be set either as input IN with type: NC, NO, EOL=10 kΩ, or output OUT (open collector (OC) 50 mA)
Output	1 pcs., relay, 1 A 30 V DC, 0,5 A 125 V AC
Connection to CMS	TCP/IP or UDP/IP via Wi-Fi
Event transmission protocol	TRK_TCP or TRK_UDP
Encryption key	6 symbol encryption key
Wi-Fi frequency	2,4 GHz
Wi-Fi protocol	802.11 b/g/n
Security mode	WPA, WPA2, WPA mixed
Network configuration type	DHCP or manual network configuration (using phone or laptop)
Unsent events memory	Up to 60 events
Event log memory	Up to 5000 events
Users who have permission to control	1000
Operating environment	Temperature from -10 °C to 50 °C, relative humidity - up to 80% at +20 °C
Communicator dimensions	88 x 62 x 26 mm
Weight	0.08 kg

WORKS WITH  
**protegus2**  
intelligent security & control



# RF-LoRa Transceiver

## Range of operation up to 1000 m

▼ LORA EQUIPMENT RECEIVER RF-LORA

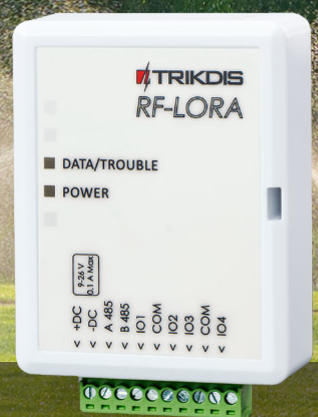

The RF-LORA wireless transceiver is designed to work with TRIKDIS LoRa wireless equipment.

The transceiver is easy to connect to the FLEXi SP3 control panel and ensures a reliable and secure connection. The transceiver can be used with a iO-LORA and iO8-LORA expanders.

LoRa (short for long range) is a spread spectrum modulation technique derived from chirp spread spectrum (CSS) technology. Semtech's LoRa is a long range, low power wireless platform that has become the de facto wireless platform of Internet of Things (IoT).

LoRa devices have amassed several hundred known uses cases for smart cities, homes and buildings, communities, metering, supply chain and logistics, agriculture, and more.

# FEATURES

## Communication:

- Line-of-sight wireless range up to 1000 m.
- One RF-LORA transceiver can be connected to the "FLEXi" SP3 control panel.

## Connection:

- The RF-LORA transceiver is connected to the "FLEXi" SP3 control panel via the RS485 bus.

# SPECIFICATIONS:

Power supply voltage	9-26 V DC
Current consumption	Up to 50 mA (stand-by) Up to 150 mA (short-term, while sending)
Transmission frequency	433,3-434,7 MHz
Modulation type	LoRa
Report encryption	Yes
Range in open space	1000 m
Operating environment	Temperature from -10 °C to 50 °C, relative humidity - up to 80% at +20 °C
Communicator dimensions	62 x 82 x 25 mm
Weight	0.08 kg

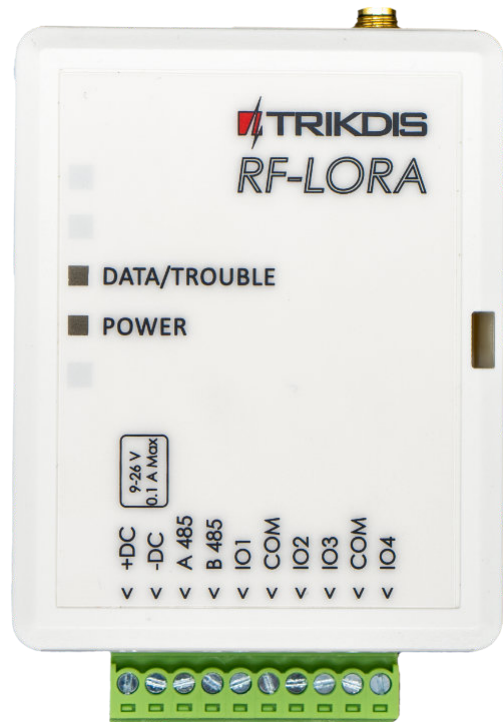

# iO-LoRa expander

## Range of operation up to 1000 m

### With integrated relay

iO-LORA is LoRa wireless expander that expands the number of inputs and outputs with RF-LORA module for FLEXi SP3 control panel using a two-way LoRa wireless connection. The operating range is up to 5000 m. It also has an integrated contact with a relay.



LoRa (short for long range) is a spread spectrum modulation technique derived from chirp spread spectrum (CSS) technology. Semtech's LoRa is a long range, low power wireless platform that has become the de facto wireless platform of Internet of Things (IoT).

LoRa devices have amassed several hundred known uses cases for smart cities, homes and buildings, communities, metering, supply chain and logistics, agriculture, and more.

# FEATURES

### Communication:

- Line-of-sight wireless range up to 1000 m.
- Up to 8 iO-LORA wireless expanders can be connected to the "FLEXi" SP3 control panel.

### Inputs and outputs:

- Bus "1-Wire" is intended for connection of temperature sensors (up to 4 pcs.) and readers of contact ("iButton") keys.
- 1 input, of selectable type: NC, NO.
- 1 output (relay).

### Connection:

- The iO-LORA wireless expander is connected to the "FLEXi" SP3 control panel via the RF-LORA transceiver.

# SPECIFICATIONS:

Power supply voltage	9-26 V DC
Current consumption	Up to 50 mA (stand-by) Up to 150 mA (short-term, while sending)
Transmission frequency	433,3-434,7 MHz
Modulation type	LoRa
Report encryption	Yes
Range in open space	1000 m
Input	1, selectable type: NC, NO
Output	1, relay, 250 V AC, 4 A
Temperature sensor	4, Maxim®/Dallas® DS18S20, DS18B20
Operating environment	Temperature from -10 °C to 50 °C, relative humidity - up to 80% at +20 °C
Communicator dimensions	62 x 82 x 25 mm
Weight	0.08 kg

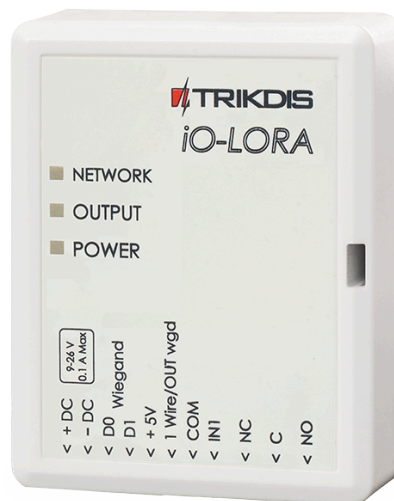

# iO8-LoRa expander

## Range of operation up to 1000 m

◀ IO8-LORA EXPANDER

### 8 I/O terminals

iO8-LORA is expander for FLEXi SP3 control panel and TRIKDIS LoRa series modules, it increase the number of inputs and outputs in a device.

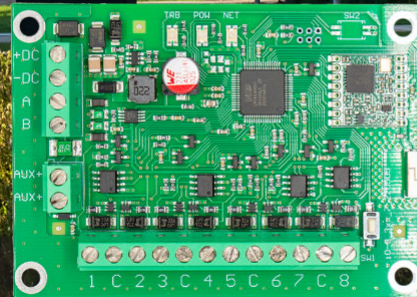

LoRa (short for long range) is a spread spectrum modulation technique derived from chirp spread spectrum (CSS) technology. Semtech's LoRa is a long range, low power wireless platform that has become the de facto wireless platform of Internet of Things (IoT).

LoRa devices have amassed several hundred known uses cases for smart cities, homes and buildings, communities, metering, supply chain and logistics, agriculture, and more.

# FEATURES

## Communication:

- Line-of-sight wireless range up to 1000 m.
- Up to 8 iO8-LORA wireless expanders can be connected to the "FLEXi" SP3 control panel.

## Inputs and outputs::

- 8 I/O terminals, each one can be set as an input (IN) or output (OUT). Input (IN) types: ATZ, EOL, NC, NO. Different value of resistors can be used in EOL and ATZ type circuits.

## Connection:

- The iO-8-LORA wireless expander is connected to the "FLEXi" SP3 control panel via the RF-LORA transceiver.

# SPECIFICATIONS:

Power supply voltage	9-26 V DC
Current consumption	Up to 50 mA (stand-by) Up to 150 mA (short-term, while sending)
Transmission frequency	433,3-434,7 MHz
Modulation type	LoRa
Report encryption	Yes
Range in open space	1000 m
Dual purpose terminals [I/O]	8, IN or OUT function selected during programming. When IN is selected, available types: NC, NO, EOL, EOL_T, 3EOL, ATZ, ATZ_T. When OUT is selected, the terminal becomes open collector (OC) type with up to 100 mA current
Operating environment	Temperature from -10 °C to 50 °C, relative humidity - up to 80% at +20 °C
Communicator dimensions	62 x 82 x 25 mm
Weight	0.08 kg

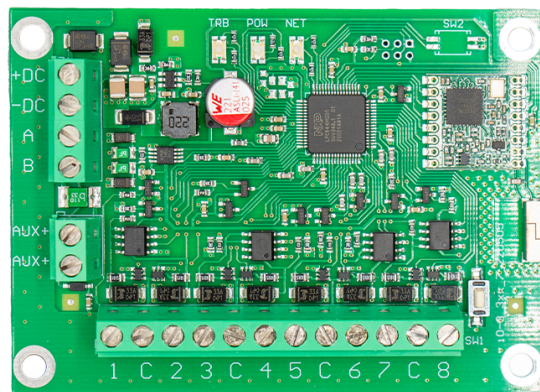



# PB-LoRa Panic Button

**Range of operation  
up to 1000 m**



◀ PB-LORA WIRELESS PANIC BUTTON

## Wireless Panic button

Upgrade your emergency response solutions with the PB-LORA panic button. The PB-LORA is designed to transmit emergency call messages wirelessly, providing your clients with a reliable and efficient emergency response solution.



With a line-of-sight wireless range of up to 5000 meters, the PB-LORA is perfect for large buildings, campuses, and other high-traffic areas. And with the ability to connect up to 250 units of panic buttons in one system, you can provide comprehensive coverage for all of your clients' needs.

The PB-LORA is designed to work seamlessly with the Flexi SP3 control panel and the Protegus 2 smart app, making it easy to integrate into your existing security solutions. Plus, with a battery life of at least 3 years, you can trust that the PB-LORA will be there for your clients when they need it most.

# FEATURES

## Communication:

- Line-of-sight wireless range up to 1000 m.

## Connection:

- The PB-LORA wireless panic button is connected to the "FLEXi" SP3 control panel via the RF-LORA transceiver.

# SPECIFICATIONS:

Transmission frequency	433,3-434,7 MHz
Modulation type	LoRa
Power supply voltage	3 V, battery CR123A
Battery life	At least 3 years
Current consumption	Up to 0,008 mA (stand-by) Up to 50 mA (short-term, while sending)
Report encryption	Yes
Range in open space	1000 m
Operating environment	Temperature from -10 °C to 50 °C, relative humidity - up to 80% at +20 °C
Communicator dimensions	62 x 77 x 25 mm
Weight	0.08 kg

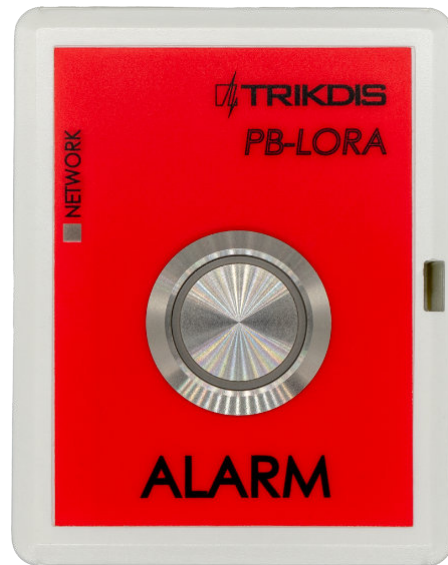



## CELLULAR SECURITY CONTROL PANEL



### Remote control

Install a simple security system that can be monitored and controlled remotely.



### Various equipment

Control various equipment remotely (e.g. heating and ventilation systems, automatic gates).



### Monitor temperature

Monitor temperature, water or fuel level, or other parameters.



### Notifications

Notify users about events.



### Notifications to the receiver

Send event notifications to the receiver of a security company.

### Sends events to monitoring station receiver:

- Sends events to TRIKDIS software or hardware receivers that work with any monitoring software.
- Can send event messages to SIA DC-09 receivers.
- Connection supervision by polling to IP receiver every 30 seconds (or by user defined period).
- Backup channel that will be used if connection with the primary channel is lost.
- Events can be reported to CMS with SMS messages. SMS will be sent even if data connection stops working in the mobile operator network.
- With parallel communication channels events can be sent to two receivers at same time.
- When Protegus 2 service is enabled, events are first delivered to CMS, and only then are sent to app users.

### Works with Protegus 2 app:

- “Push” and special sound notifications informing about events.
- Remote system Arm/Disarm.
- Remote control of connected devices (lights, gates, ventilation systems, heating, sprinklers, etc.).
- Remote temperature monitoring (with iO or iO-WL expanders).
- Different user rights for administrator, installer and user.
- Users can also be informed about events with SMS messages and phone calls.

### Notifies users about events:

- Sends SMS messages about events.
- “Push” and special sound event notifications using the Protegus 2 app.

### Remote system and output control:

- Using Protegus 2 app.
- Using contact (iButton) key reader.
- By calling the device’s phone number.
- Using SMS messages.
- Using an automatic “if...then” algorithm. E.g. when an input is enabled or the temperature exceeds a certain limit, an output will be turned on.

### Supports these expanders:

- iO series wired or wireless expanders, which increase the number of inputs (IN) and outputs (OUT).
- GPS receiver (useful for protecting ATMs and vending machines).
- Fuel or water level sensor. For protecting gas tanks or monitoring water level.
- Backup power and charging of 12 V battery.

### Inputs and outputs

- 1 input, 2 outputs and 3 double I/O terminals that can be set either as input (IN) or controllable output (OUT) terminals.
- One wire data bus (1-Wire) for connecting temperature sensors (up to 8) and a contact (iButton) key reader.
- Number of inputs (IN) or outputs (OUT) can be increased to 12 using iO series wired or wireless expanders.

### Simple installation:

- Default settings for use either as a control panel or as communicator.
- Settings can be saved to file and quickly written to other devices.
- Configuration either using an USB cable or remotely using TrikdiskConfig software.
- Two types of access levels (accounts), for the installer and for the administrator.

Parameter	Description
Dual purpose terminals [IN/OUT]	3, can be set as either NC, NO, EOL=10kΩ type inputs or open collector (OC) type outputs with current up to 100mA
Inputs [IN]	1, selectable type: NC, NO or EOL=10kΩ
Outputs [OUT]	2, open collector (OC) type, up to 1A of current
Number of areas	8
1-Wire data bus length [1 WIRE]	Up to 30 m
Compatible temperature sensors	Maxim®/Dallas® DS18S20, DS18B20
Maximum number of temperature sensors connected to the 1-Wire data bus	8
Compatible contact (iButton) keys [1 WIRE]	Maxim®/Dallas® DS1990A
Maximum number of contact (iButton) keys	12
RS485 data bus length	Up to 100m
Maximum number of devices connected to the RS485 data bus	8
Buffer memory capacity	60 events
Number of communication channels	2 (1st channel: main, backup; 2nd channel: Protegus 2)
Internal clock	Yes
Event reporting channels	GPRS or 4G, SMS
Communication with CMS	TCP / IP or UDP / IP, or SMS
Communication protocols	TRK, encrypted DC-09_2007 or DC-09_2012
Modem 4G (Europe)	<b>GSM:</b> 850 / 900 / 1800 / 1900 MHz <b>LTE FDD:</b> B1/B3/B7/B8/B20/B28A
Modem 4G (Latin America)	<b>GSM:</b> B2/B3/B5/B8 <b>LTE-FDD:</b> B2/B3/B4/B5/B7/B8/B28/B66
Power supply [AC / +DC]	16-24V DC or 16-18V AC
Current consumption	Up to 50mA (stand-by), Up to 200mA (short-term, transmitting)
Backup power supply [BAT]	12V lead-acid battery
Battery charge current	Up to 500mA
Power supply voltage and current for external devices [+12V]	12V DC, up to 1000mA
Operating environment	From -10 °C to + 50 °C, relative air humidity up to 70% at 0- +40 °C (no condensation)
Dimensions	113 x 70 x 25mm
Weight	0.10 kg

# T16

## TIMELESS SOLUTIONS FOR NEXT-GENERATION SECURITY

### RELIABLE COMMUNICATION

The T16 radio transmitter is a multifunctional radio device used for transmitting security control panel event messages via radio networks, ensuring reliable communication between your security system and the CMS.

### VERSATILE TRANSMISSION

Flexible transmission options, including the possibility to use an external IP transmitter as the primary communication channel. It supports the transmission of event messages using Contact ID and 4+2 codes, making it easy to integrate with various security control panels.

### EASY CONFIGURATION

Quick and easy installation, with firmware updates that can be easily applied. It offers two access levels, one for the installer and one for the administrator, and can be configured remotely when an IP transmitter is used.

### MULTIPLE INPUT AND OUTPUT OPTIONS

Multiple input and output options, including a universal serial port for connecting various security control panels, a TIP/RING landline interface that can accept messages in Contract ID and 4+2 codes, and an RS485 interface for IP transmitters and extension modules. This makes it a versatile choice for different security systems and control panels.

The T16 radio transmitter is a reliable and versatile radio device that ensures constant communication between your security system and the CMS. It offers flexible transmission options, easy configuration, and multiple input and output options, making it a suitable choice for different security systems and control panels.



# FEATURES

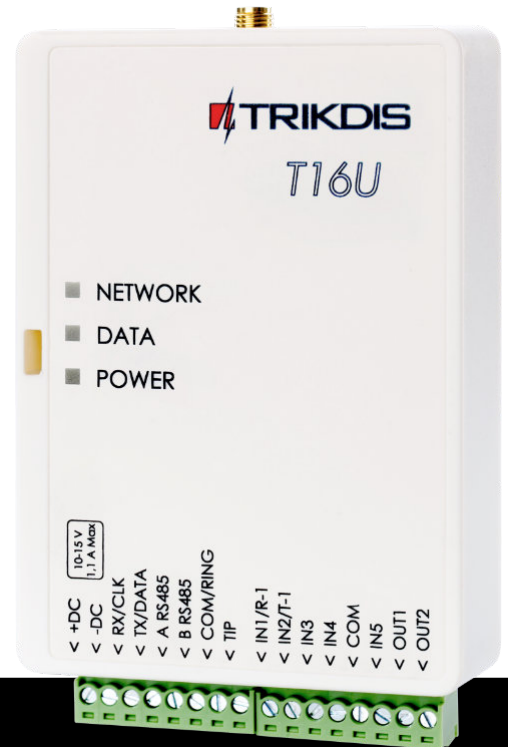

## Communication

- Sends event messages to CMS.
- RAS3, RAS2M, LARS1, LARS radio network protocols.
- Output power from 1 W to 5 W.
- Possibility to use external IP transmitter as main communication channel.
- Transmission of event messages using Contact ID and 4+2 codes.
- Use of security control panel account ID for multi-area systems.

## Configuration

- Quick and easy installation.
- Firmware updates.
- Two types of access levels (accounts), for the installer and for the administrator.
- Possibility to configure remotely when an IP transmitter is used.

## Serial port, inputs and outputs

- Universal serial port for connecting various security control panels.
- TIP/RING landline interface can accept messages from the control panel in Contract ID and 4+2 codes.
- RS485 interface for IP transmitters and extension modules.
- 6 inputs, selectable types: NC, NO, EOL (2,2 k $\Omega$ ). (T16V, T16U)
- 5 inputs, selectable types: NC, NO, EOL (2,2 k $\Omega$ ). (T16U5)
- 1 output. (T16V, T16U)
- 2 output. (T16U5)

Parameter	T16U
Power supply voltage	10-18 V DC
Current consumption	100 mA (on standby) Up to 250 mA (while sending data)
Radio frequencies	430 MHz – 512 MHz (UHF)
Radio channels	2
RF output resistance	50 $\Omega$
Secondary emissions	Meets the requirements of EN 300 113
Broadcasting protocols	RAS3, RAS2M, LARS, LARS1, LARS_RAS2M, LARS1_RAS2M
Broadcasting time	60-400 ms (depends on chosen radio protocol)
Memory	Up to 32 messages
Inputs	6, selectable types: NC, NO, EOL (2,2 k $\Omega$ )
Output	1, OC type, commutation voltage 15 V, 1 A
Event message format	Contact ID; 4+2
Operating environment	Temperature from -10 °C to 50 °C, relative humidity - up to 80% at +20 °C
Dimensions	113 x 71 x 26 mm
Weight	0,10 kg

# W485 WI-FI MODULE

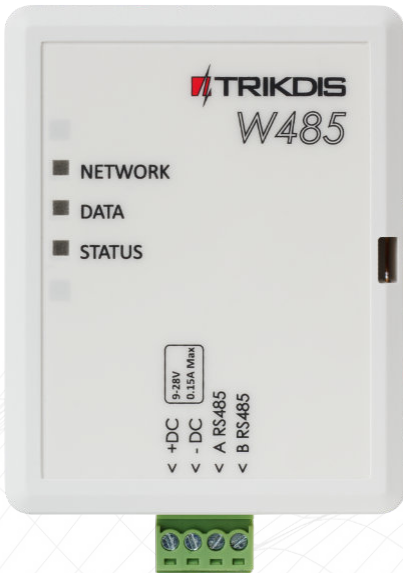

## Secure connection

Main WiFi channel, GPRS - backup.



## Works with the Protegus 2 app

Users can remotely arm / disarm their alarm system and receive notifications about events.



## Simple connection

No additional configuration.



## Less use of data

Sends messages via Wi-Fi, mobile data traffic for messaging is not used.

**W485** Wi-Fi module is an add-on to TRIKDIS communicators G16, G16T, control panel SP231 and radio transmitter T16, providing WiFi connectivity.

With communicators G16 and G16T it provides a transparent primary communication channel via WiFi. This allows to control the alarm system with communicator remotely via Protegus 2 app when it is connected via WiFi.

When you connect the W485 to the G16 / G16T, all the features of the communicator you use will remain:

- Transmission of events from Paradox, DSC, Texecom, Inetrlogix, Honeywell and other alarm panels to the CRA;
- Connection with Protegus 2 Cloud and Protegus 2 application;
- Remote control of Paradox, DSC, Texecom, Inetrlogix, Honeywell and other brands;
- Remote programming through the TrikdisConfig and all other functions.

Power supply	9-28 VDC
Current consumption	150 mA (in standby mode), Up to 200 mA (while sending data)
Compatible with	Trikdis communicator G16 / G16T Trikdis control panel SP231 Trikdis T16 radio transmitter
Wi-Fi frequency	2.4 GHz
Wi-Fi protocols	802.11 b/g/n
Type of Wi-Fi antenna	Internal
Security mode	WPA, WPA2, WPA mix
Network configuration type	DHCP or manual network configuration (using phone or laptop)
Operating environment	From -10 ° C to 50 ° C, relative humidity - up to 80% at +20 ° C
Dimensions	88 x 62 x 26 mm

# E485

# ETHERNET MODULE

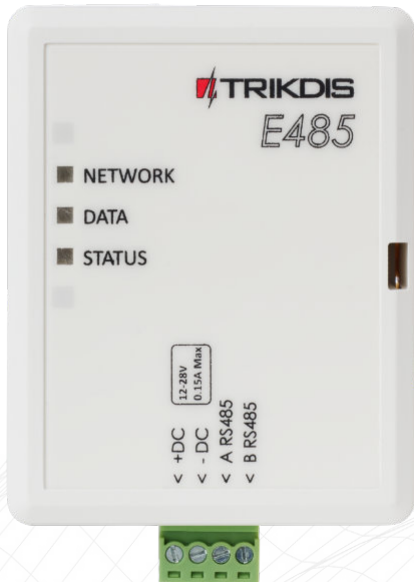

## Secure connection

Main Ethernet channel, GPRS - backup.



## Works with the Protegeus 2 app

Users can remotely arm / disarm their alarm system and receive notifications about events.



## Simple connection

No additional configuration.



## Less use of data

Sends messages via ethernet, mobile data traffic for messaging is not used.

The "Ethernet" **module E485** is compatible with the GSM communicators G16 and G16T (firmware from 1.32) and is designed to transmit data and control commands via the wired Internet network. By using the **E485** in conjunction with the G16 or G16T, messages are sent to the CMS (central monitoring station) via the wired internet network and in this case the mobile Internet is not used. When communication is interrupted on the wired internet network, messages are sent to the monitoring station via the mobile internet network.

**E485 Module** transmits complete information about events to the monitoring station receiver.

### Connection

- Connection type: wired internet.

### Settings and installation

- Quick and easy installation.

### Communication

- Two primary connection channel and two secondary connection channel.
- Alternative sending of event logs to Protegeus 2 app, which allows the user to monitor the security system remotely.
- The communicator uses Contact ID codes to transmit event messages.

Power supply	12-28 VDC
Current consumption	50 mA (stand-by) Up to 150 mA (transmitting)
Compatible with	Cellular communicator G16 and G16T (firmware 1.32), CG17, G17F, GV17, T16
Connection to CMS	TCP/IP or UDP/IP via LAN
Event transmission protocol	TRK_TCP or TRK_UDP
Event sending	In Contact ID codes
Encryption key	6 simbol encryption key
Ethernet PHY	IEEE802.3, 10-100BaseTX, Full-duplex, RJ45 port
Network configuration type	DHCP or manual network configuration (from the main managed device G16 or G16T)
Operating environment	From -10 ° C to +50 ° C, relative humidity - up to 80% at +20 ° C
Dimensions	88 x 62 x 26 mm

# iO8 INPUT AND OUTPUT EXPANDER

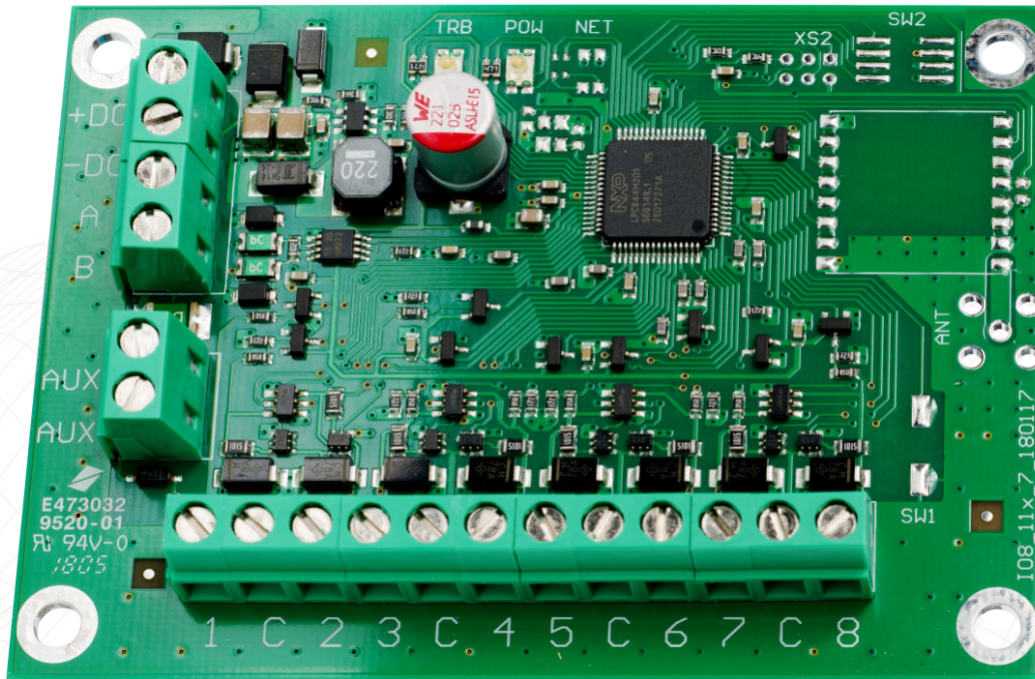

## ◀ INPUT AND OUTPUT EXPANDER

Increase the number of inputs and outputs in a compatible TRIKDIS device

### iO-8 features:

- Eight contacts, which can be set to either input or output mode.
- Plug-and-play installation.
- Setup through the main TRIKDIS device.

iO-8 is compatible with these TRIKDIS devices:

- FLEXi SP3
- Controller CG17
- Communicator G16
- Communicator G16T
- Communicator G17F

Power supply voltage	10-18V DC
Current consumption	Up to 20mA
AUX output voltage	Up to 1A
IO number	8
Input type	NC, NO, EOL
Input voltage	Up to voltage of power supply
EOL nominal resistivity	2,2kΩ or 10kΩ (depending on main TRIKDIS device)
Output type	OC
Output voltage	0V-18V
Output current	Up to 100 mA
Operating environment	From -10 °C to +55 °C, with relative air humidity 80% when +20 °C

# G17F CELLULAR COMMUNICATOR FOR FIRE PANEL

CELLULAR COMMUNICATOR (FOR FIRE PANEL)



## SMALL SIZE, BIG IMPACT - INSTALL WITH EASE!

Simple and fast to install communicator which will upgrade any fire alarm panel for event signaling via cellular network. Compact size allows for flexible placement options, even in areas with limited space.

When triggered, the communicator transmits event information to the Alarm Receiving Centre (ARC). Additionally, customers can receive notifications about fire alarm events through the Protegus 2 app.

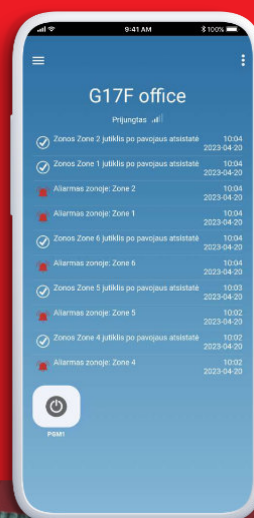

### Communications:

- One main communication channel
- Two back-up channels
- Connection control with ARC
- Event messages are transmitted in Contact ID codes
- Informing customers about events with:
  - Protegus 2 apps
  - SMS messages

### Configuration:

- Quick and easy installation
- Remote configuration and firmware updates

### Inputs and outputs:

- 6 selectable type inputs: NC, NO, EOL (10kΩ).
- RS485 connection
- 3 input, 3 double purpose screw terminals for setting either input or output functionality
- Using iO series expanders it is possible to expand number of inputs up to 12
- Outputs can be controlled via:
  - Mobile/Web Protegus 2 application or
  - SMS/Call

GSM	850 / 900 / 1800 / 1900 MHz
LTE FDD	B1/B3/B7/B8/B20/B28A
Power supply voltage	9-32 VDC
Current consumption	100 mA (standby) Up to 200 mA (transmitting)
Transmission protocols	TRK
Communication with ARC	TCP/IP or UDP/IP, SMS
Memory	Up to 60 messages
Inputs and outputs	3 inputs, 3 double purpose contacts for setting either input or output functionality Selectable type inputs: NC, NO, EOL (10kΩ)
Event transmission	Contact ID codes
Encryption key	6 symbols encryption key
Parameter configuration	Locally via USB port or remotely
Operating environment	Temperature from -10 °C to 50 °C, relative humidity – up to 80% at +20 °C
Communicator dimensions	77 x 62 x 25 mm
Weight	0.08 kg

# FireCom

Empower Your Fire Security

## Your Solution for Reliable Fire Communication

As a security company or installer, you understand the critical importance of fire communication. Don't compromise on reliability and performance. FireCom, the ultimate fire communicator that ensures seamless and secure fire reporting to monitoring centers. With its cutting-edge features and robust design, FireCom is the trusted choice for security professionals who demand the best. Secure your world with FireCom today.

### Support for CID and SIA DC09 Reporting

FireCom provides flexible reporting options, allowing you to choose the method that best fits your monitoring center requirements.

### Robust metal casing with additional options

FireCom comes in a medium-sized metal casing with an additional power supply, battery, and expansion board, ensuring greater durability and reliability in demanding conditions.

### LTE or LTE-M Connectivity

FireCom offers reliable and secure connectivity options with LTE or LTE-M.

### Onboard Temperature Sensor and Watchdog Timer

FireCom features built-in temperature sensing and watchdog timer for enhanced performance and reliability.

### Expandable Input/Output Options

The FireCom system can be easily expanded by adding extra modules that connect to RS485, allowing for additional inputs (zones). This flexibility caters to various installation requirements.

### Indication and Control

FireCom includes onboard buzzer, LED indicators for system status, reset and silence button.

### EN54 certified

FireCom is EN54 certified, guaranteeing compliance with the strictest fire safety and communication standards in the industry. This certification ensures reliable performance in critical fire alarm systems, making it suitable for use across Europe and other regions that require EN54 compliance.



## Messages to the security company

- Sends events via the built-in LAN module or cellular 4G modem.
- Events are sent via available communication channels with the selected priority.
- Any CMS can receive reports, as long as they have TRIKDIS software/IP receiver or any other manufacturer's IP receiver supporting SIA DC-09 IP protocol.
- Prioritizing the transmission of events to the CMS: messages are first transmitted to the CMS and only then to **Protequs 2**.
- Possibility to send event reports to CMS of two different security companies.
- Event messages are sent in Contact ID or SIA codes.

## Messages to users

- Calls selected phone numbers (up to 8 users).
- Sends SMS messages about events.
- Push and special sound event notifications using the **Protequs 2** application.
- Remote temperature monitoring.

## Remote control of outputs

- Via **Protequs 2** app.
- By calling the device's phone number.
- Via SMS messages.

## Settings and installation

- Quick and easy installation.
- Device configuration either using an USB cable or remotely using **TrikidisConfig** software.
- Remote updating of firmware.
- Two access levels (types of accounts) for setting parameters: for the installer and for the administrator.

## Inputs and outputs

- 3 relay outputs (1 A, 30V DC).
- Input "FLOOP" is intended for connection of two-wire fire detectors.
- 10 I/O terminals, each of which can be set as an input (IN) or output (OUT) terminal. Selectable Input (IN) types: NC, NO, EOL, EOL-T, ATZ, ATZ-T. Resistors of different ratings can be used in EOL and ATZ circuits.
- With **iO** expander modules, the number of IN inputs can be expanded up to 32 units, and the number of OUT outputs can be expanded up to 16 units.
- RS485 bus is used to connect **iO** series expander modules.

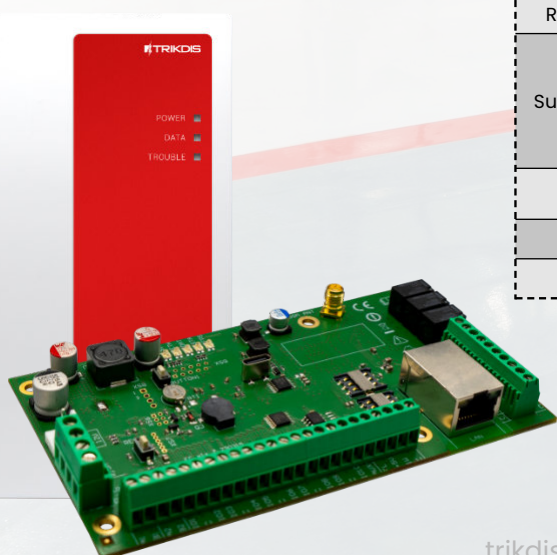

Parameter	Description
LTE modem frequencies: EU (Europe) LA (Latin America)	LTE-FDD: B1/B3/B5/B7/B8/B20/B28 LTE-FDD: B2/B3/B4/B5/B7/B8/B28/B66
Power supply voltage	100-240VAC, 0,9A
Current consumption	Up to 50 mA (stand-by). Up to 300 mA (transmitting). Up to 2.5 A (after connecting the maximum possible load with external devices).
Backup power source [BAT]	12 V lead – acid battery, 4 Ah/7 Ah
Battery charge current	Up to 500 mA
Power voltage and current for external devices [AUX]	12 V DC, up to 1 A
Transmission protocol	TRK, SIA DC-09_2007, SIA DC-09_2012, SIA DC-09_IPcom, TL150
Encryption key	6 symbol encryption key.
Connection to CMS	TCP/IP or UDP/IP
Event codes	Contact ID, SIA codes.
LAN module	Yes, built-in
LAN network configuration type	DHCP or manual
SIM card	1, NANO size
Report transmission directions	-To main and backup receivers of 2 different security companies; -To Protequs 2 cloud, to iOS/Android Protequs 2 mobile apps; -To 8 mobile phones via SMS messages. -Calls 8 mobile phones.
Event reporting transmission channels	4G, Ethernet (LAN), SMS, call
Message encryption	Yes
Internal clock	Yes
User	40
Dual purpose terminals [I/O]	10; IN or OUT function selected during programming. When IN is selected, available types: NC, NO, EOL, EOL_T, ATZ, ATZ_T. When OUT is selected, the terminal becomes open collector (OC) type with up to 100 mA current
No. of groups	8
No. of zones	10 (20 zones if using ATZ), (can be expanded to 32 zones using expanders)
No. of PGM outputs	3 relay (1 A, 30V DC). (can be 13 if IO terminals are set as outputs. Can be expanded to 16 outputs with expanders)
Buffer memory capacity	60 events
Events log memory	Up to 1000 events. Oldest entries deleted automatically.
Configuration	Remotely using TrikidisConfig software or locally using USB Type-C. Remotely using SMS messages.
1-Wire data bus length [1 WIRE]	Up to 30 m
Compatible temperature sensors	Maxim«/Dallas« DS18S20, DS18B20; AM2301 series
Max. number of temperature sensors connected to 1-Wire data bus	8 (Dallas) or 1 (if an AM2301 series sensor is used)
RS485 bus	2
RS485 bus length	Up to 100 m
Supported modules	iO-8 – expander module; iO-MO – iO-WL radio wave transceiver; iO-LORA – expander module; iO8-LORA – expander module; PB-LORA – panic button; REL-LORA – expander module.
Operating environment	Temperature from -10 C to +50 C, relative air humidity – up to 80% at +20 C.
Dimensions	139 x 78 x 20 mm
Weight	1.19 kg

# MODULE SF485

Designed to work with TRIKDIS communicators



**When popular transmission to CMS not safe enough**



VIA  
SIGFOX  
NETWORK

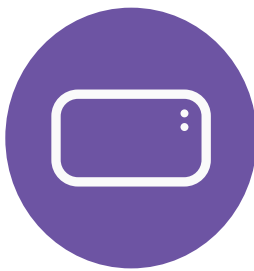

FOR  
ANY ALARM  
PANEL



WITH  
TRIKDIS  
COMMUNICATOR

SF485 works as a secondary channel for security panel events transmission to Central Monitoring Station (CMS) or Protegus 2 mobile app when the primary channel fails.



**No settings required**



**Contact ID events**



**RS485 interface**

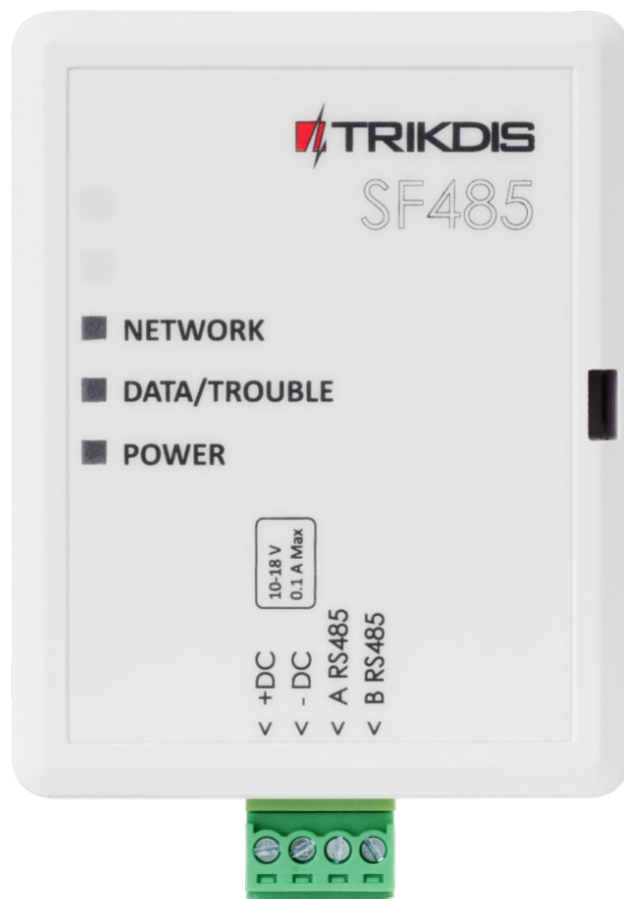

Parameter	Description
Power supply voltage	10-18 V DC
Current consumption	Up to 15 mA (stand by) Up to 60 mA (short-term, transmitting)
Network	Sigfox
Region	RC1
Device uplink radiation class	0U*
Sigfox ready certificate	P_01B8_6C72_01
Event reporting protocol	Contact ID
Interface	RS485
Protection class	IP20
Operating environment	Temperature from -10 °C to +50 °C, relative humidity 80% at +20 °C, no condensation
Dimensions	92 x 62 x 26 mm
Weight	70 g



WORKS WITH  
**protegeus<sub>2</sub>**  
intelligent security & control





# App to make your work smarter.

Meet better Protegeus.

You can manage module configurations from anywhere you are at any time.

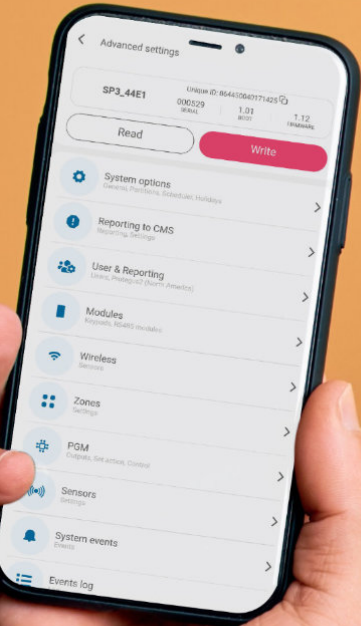

**Connect directly to the module via Protegeus 2 app!**

Protegeus 2 now has a new Advanced settings feature. It has been created with the aim to make everyday work easier by integrating all TrikdConfig features in one simple app.



Protegeus 2 is a trusted and reliable security app, which helps you to protect. It provides you a smart security system, with clear status and easy to use interface.

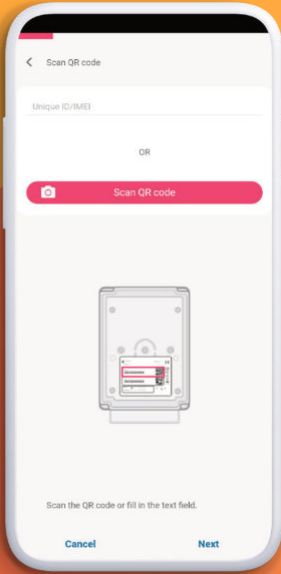

### Add system in 60 seconds

With Protegeus 2 you can set up a system in just 60 seconds, it takes just a few clicks. And quickly start managing the security system.



### FLEXi SP3 all features

Our latest security control panel FLEXi SP3 has many features. And the new Protegeus 2 enhance all of them because it was developed based on the FLEXi functionality.

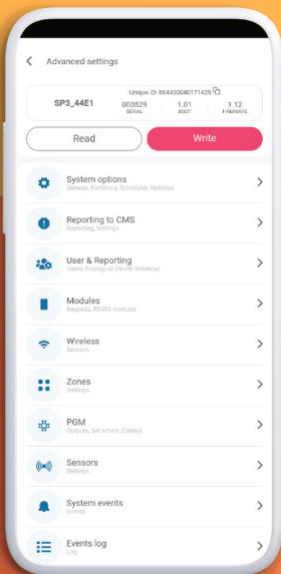

### Advanced settings

TrikdisConfig in the app. The new Protegeus 2 app makes it possible to configure your module from your phone, no more hassle with a laptop. Customize the system with Protegeus 2 and make whatever changes you want.

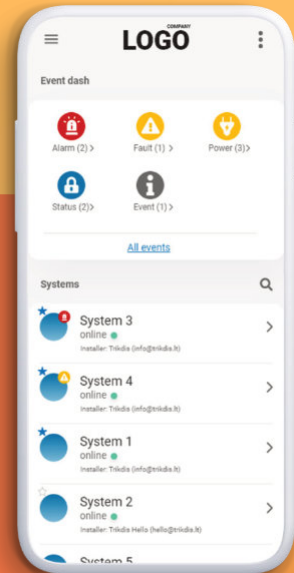

### Company account

A company that installs Trikdis products and adds them to Protegeus 2 may have a Protegeus 2 Company account. This Protegeus 2 Company account will allow the company to administer installed products that are added to their company.

You will be able to customize your brand colors, logos, and icons for your clients to recognize you. Also, change reaction types or names, and monitor all security systems on the dashboard.

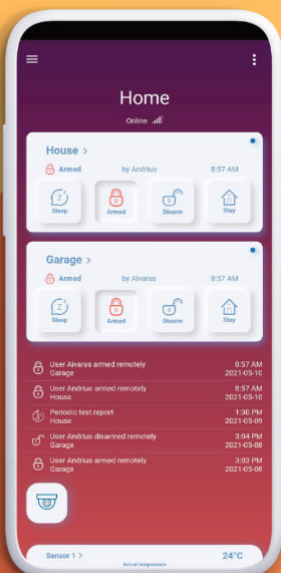

### Direct read from module

All pre-configured settings will be visible as soon as you add the system to the application. Or configure on the go.

No more double configuration.



# App to make your property safer.

## Meet better Protegus.

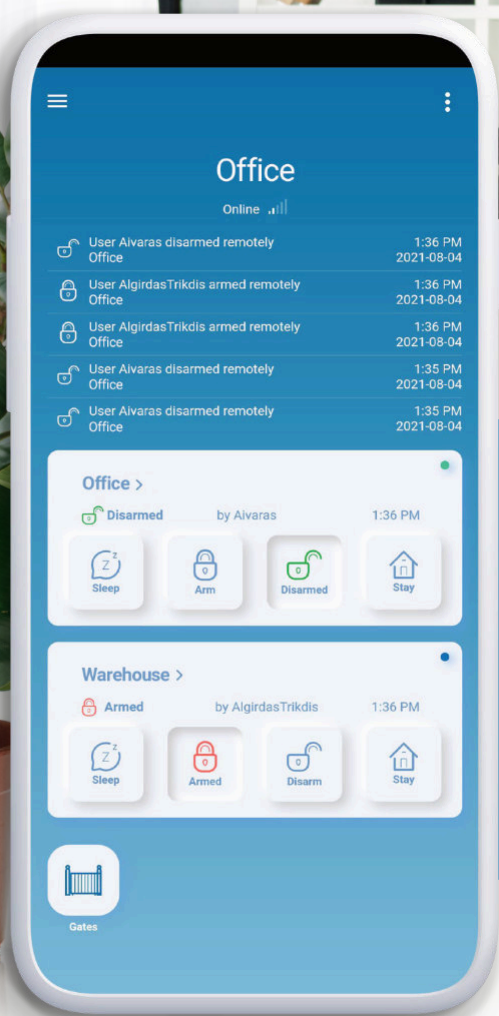

Protegus 2 is a trusted and reliable security app, which helps you to protect your home and office premises. It provides you the best security system with clear status and easy to use interface. Protegus 2 can be used as a stand alone or incorporated into your existing smart home system.

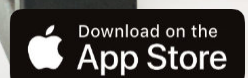

More info at [trikdis.com](http://trikdis.com)

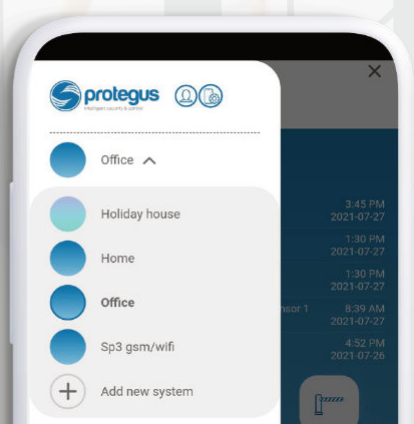
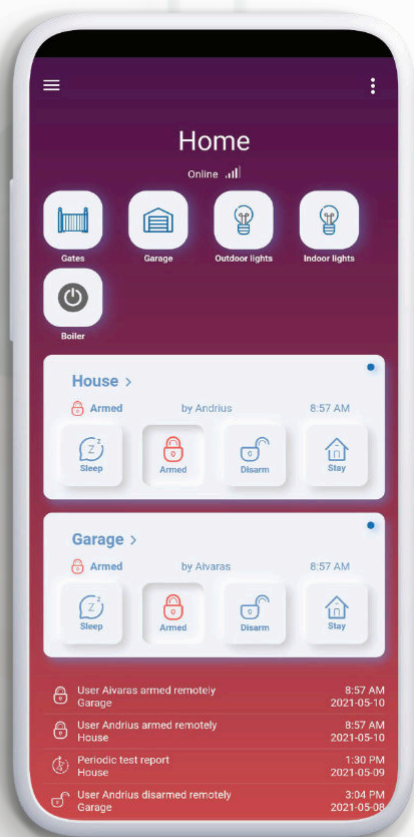
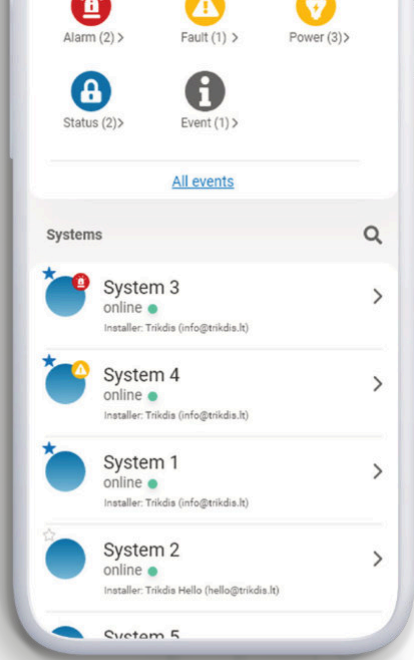
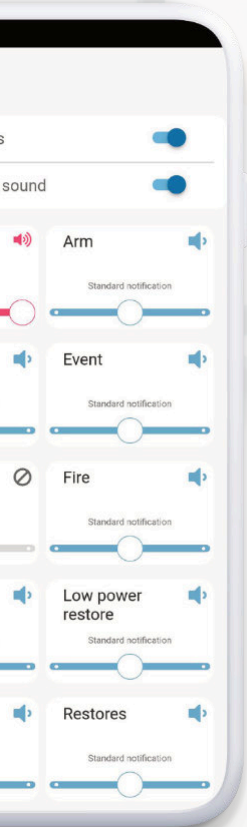
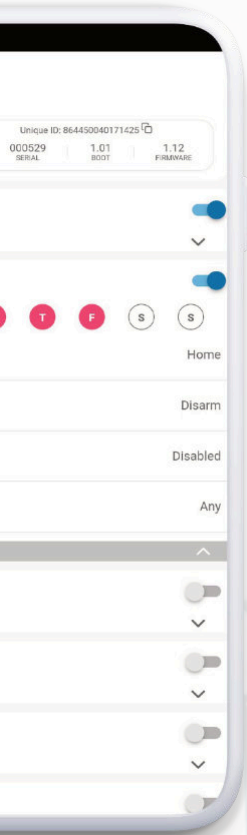
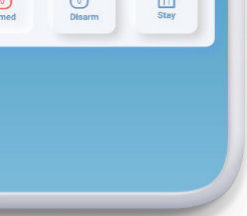

## Customization

Use the Protegus 2 app to customize your security system with your favourite colours and images. You can tailor the app to perfectly fit your lifestyle, creating a happy place that helps you start and end your day.



## Better widgets

You can add widgets on your phone home screen and they are the same as in the app. You always see your status, and you always will be able to control the system without loading the app.



## Company account

A company that installs Trikidis products and adds them to Protegus 2 may have a Protegus 2 Company account. This Protegus 2 Company account will allow the company to administer installed products that are added to their company.

You will be able to customize your brand colors, logos, and icons for your clients to recognize you. Also, change reaction types or names, and monitor all security systems on the dashboard.



## New interface

The technology is more user-friendly than the average smart security system, no more dead ends or hard to understand features.



## FLEXi SP3 all features

Our latest security control panel FLEXi SP3 has many features. And the new Protegus 2 enhance all of them because it was developed based on the FLEXi functionality.

# App to make your home safer. Meet better Protegus.

Monitor your home security system, control it remotely, and get real-time notifications.

Protegus 2 is a home monitoring app that provides peace of mind by both securing and monitoring your property. Once activated, it records and sends you real-time alerts if an intruder breaks in, nearby emergency situations, and live video streams from your house when things get interesting. Linking to a mobile app means you can take action from anywhere in the world. Protect what matters most from the comfort of wherever life takes you.

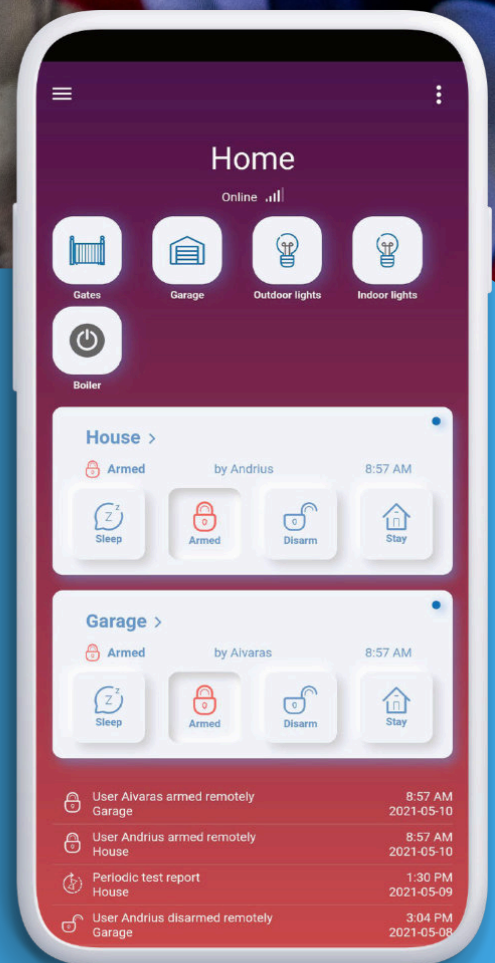



## Thermostat control

You'll never need a wall mount thermostat again! Set your desired comfort temperature for room then Protegus 2 takes care of the rest. Wherever you are, you can always make any adjustments and check system status.

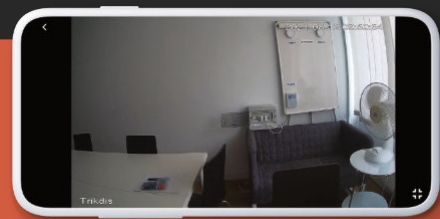

## IP cameras

The Protegus 2 app connects with all of cameras in the market with RTSP link to make scaling your smart home security system as simple as can be.

## Don't miss a thing

Know immediately when someone's unlocks doors or disables security system. You can easily administrate the users, give them access or remove from the system.

## Security & alarm

Enable or disable your security system through the app. You can also view the current status of your alarm, even when you're out and about. If your system detects a danger you'll be notified immediately.

## Water leak? Fire?

Detect potential dangers such as a water leak or fire. Your system will inform you via Protegus 2 immediately so you can take action before it turns into a costly problem.

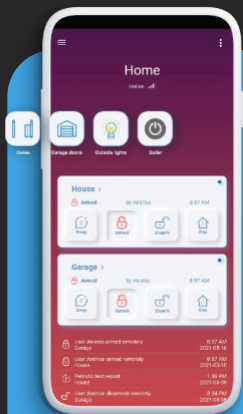

## Garage/gates

Control your garage doors or electric gates from the Protegus 2 App. You can also check status of a door when you're not home for extra peace of mind.

## Company account

Administrate your clients in the app

A Company account is built for companies managing multiple client installations. It speeds up system installation and day-to-day administration by keeping all systems, users, and access rights accessible directly from the app – right from your pocket.

## Make sure your home is always secure.

Download the Protegus 2 app to manage your security system. Download the app now on your Android or iOS device.

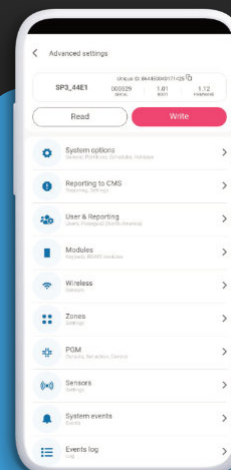

## Advanced settings

Feel like an advance Trikidis user or installer? The new Protegus 2 app makes it possible to configure your security settings from your phone, no more hassle with a laptop. Customize your app with whatever changes you want.

**Cloud**



**End User**

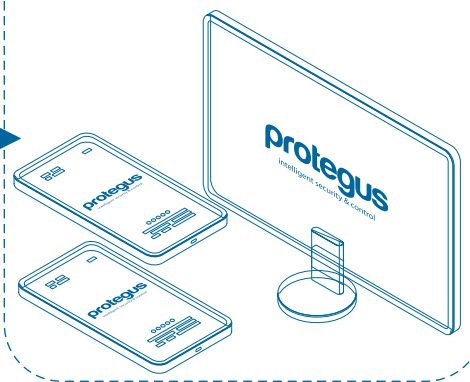

**App for Any Alarm Panel**

**Universal Communicators**



**Any Security Panel**

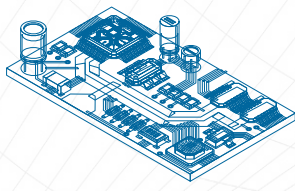

**Alarm Monitoring Software**

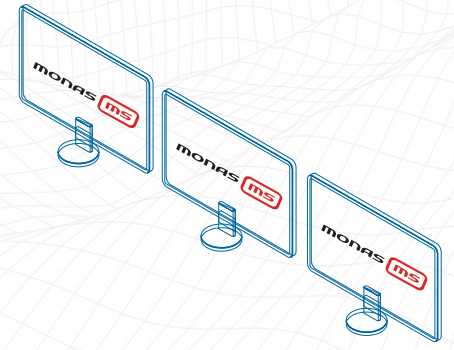

(((VHF/UHF)))

LAN

(((2G/4G/LTE)))

**Alarm Reception Center**

**Full Alarm System**

**Cellular Control Panels**



(((2G/4G/WiFi/LAN)))

**Any Other Monitoring Software**

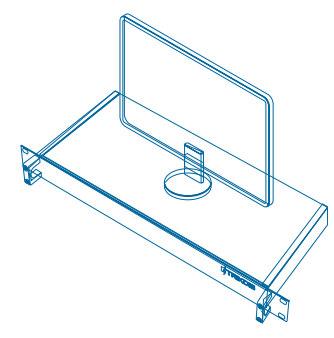

# Software & Hardware receivers for the CMS

Trikdis offers a robust solution for receiving alarm signals from your security panels to your Central Monitoring Station (CMS). Our hardware and software receivers ensure seamless communication and real-time event monitoring, keeping your clients safe and secure.

up to **5000** objects

up to **15000** objects

up to **3000** objects

or

up to **15000** objects



IP receiver	✓	✓	✓
SMS receiver	Internal / SMPP	OPT / SMPP	On request
Receiving via RS232	3	✓	✓
LAN IP output	Multiple	Multiple	Multiple
Trikdis device remote configuration	✓	✓	✓
Trikdis device remote control	✓	✓	✓
Trikdis device info (software version, IMEI, MAC)	✓	✓	✓
Protegus 2 app	✓	✓	✓
Supervision	✓	✓	✓
Events routing	✓	+Repeat Filter	+Repeat Filter
Object data export to file	✓	✓	✓
Filter for radio messages	✓	✓	✓

# FLEXi

## Adaptable security system

### Legend

- Trikdis Universal
- Wireless
- LoRa Wireless
- Internet connection

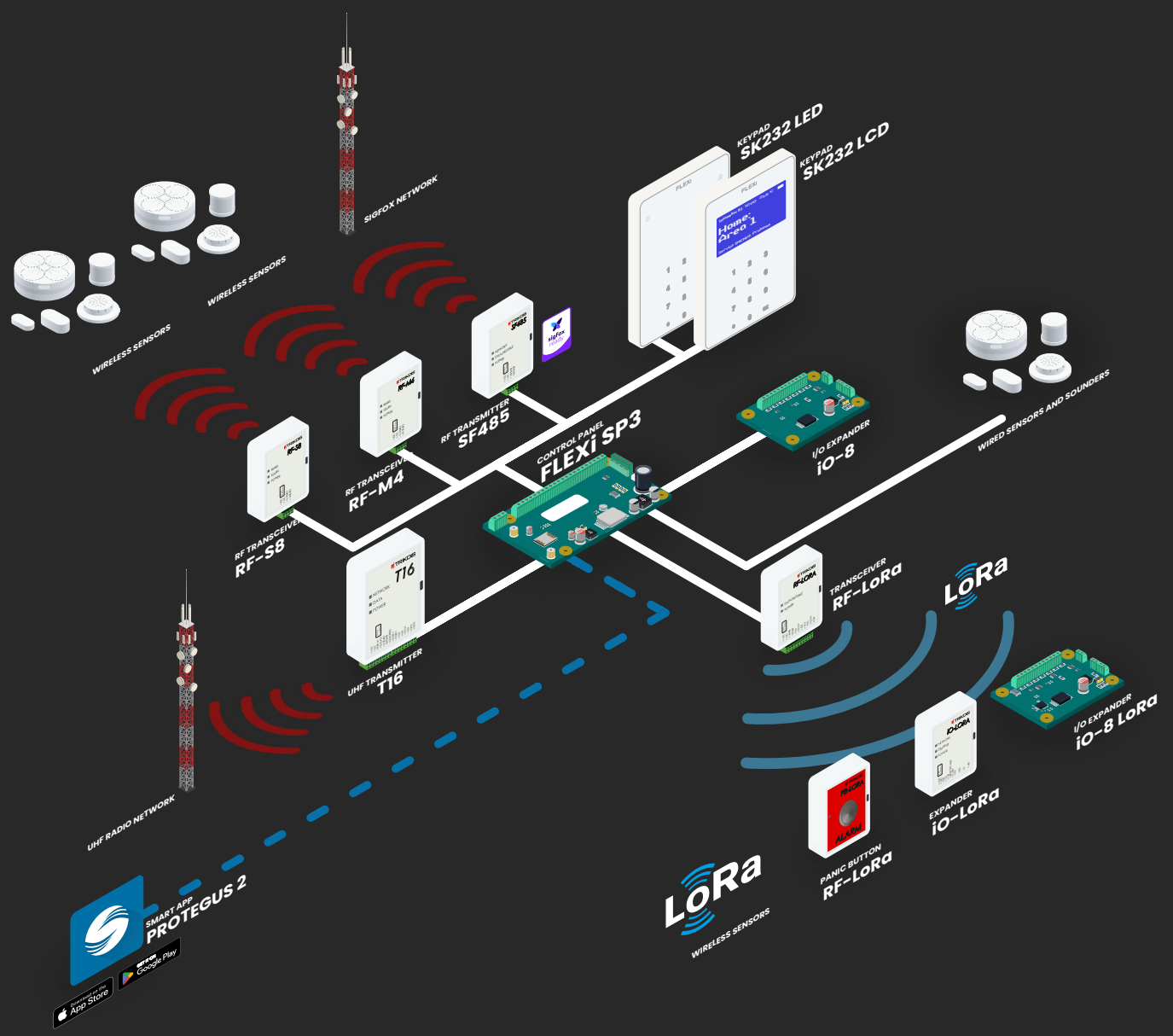

**EVERY NOTE MATTERS**



**EVERY NOTE MATTERS**

# RELIABLE ADAPTABILITY TO THE NEW SECURITY SYSTEMS



Address: Draugystės g. 17, LT-51229 Kaunas, Lithuania  
Tel. +370 37 408040  
Email: info@trikdis.lt

[www.trikdis.com](http://www.trikdis.com)

